



**PROFESSIONAL PA AMPLIFIER
AMPLIFICATEUR PROFESSIONNEL PA
PROFESSIONELLER PA VERSTÄRKER**



PAA-60USB (95-1000)

**GB - User Manual
F - Manuel d'Utilisation
D - Bedienungsanleitung
PT - Manual de Instruções**



IMPORTANT NOTE: Electric products must not be put into household waste. Please bring them to a recycling centre. Ask your local authorities or your dealer about the way to proceed.
NOTE IMPORTANTE : Les produits électriques ne doivent pas être mis au rebut avec les ordures ménagères. Veuillez les faire recycler là où il existe des centres pour cela. Consultez les autorités locales ou votre revendeur sur la façon de les recycler.

WICHTIGER HINWEIS: Elektrogeräte gehören nicht in den Hausmüll. Sie müssen in speziellen Betrieben recycelt werden. Bringen Sie sie zu einer speziellen Entsorgungsstelle für Elektrokleingeräte (Wertstoffhof)
BELANGRIJK: De elektrische producten mogen niet naast het huisvuil geplaatst worden. Gelieve deze te laten recycleren daar waar er centra's hiervoor voorzien is. Raadpleeg de plaatselijke autoriteiten of uw verkoper ivm de manier van recycleren.

NOTA IMPORTANTE: Produtos eléctricos não deverão ser postos em contentores de lixo caseiros. Por favor, deposite-os em contentores para reciclagem. Questione as autoridades locais ou onde adquiriu o produto sobre como deverá proceder.

© Copyright Lotronic 2010

- 7.USB Port (hold 2 sec the volume-)
- 8.Siren Switch
- 9.MIC-1 Volume Control
- 10.MIC-2 Volume Control
- 11.Repeat
- 12.Sound effect

Thank you for choosing P.A. This attractive unit will give you many years of listening pleasure.

Please read the installation and operation instructions in this manual and keep it for reference.

SPECIFICATIONS

MP3,USB,SD player included

Inputs :

- 1 MP3 Player
- 1 USB Port
- 1 SD Port
- 2 Microphones -42dB 10KΩ / 50KΩ
- 1 AUX -20dB 10KΩ / 50KΩ

Output:

- Power: 45 Watts Peak, 35 Watts RMS
- Less Than 3% THD @ 1KHz
- Speaker Impedance: 4~ 8~16Ω 70V
- Frequency Response: 150Hz~15 KHz
- Power Supply: AC 110/220V, DC 12V

FRONT PANEL

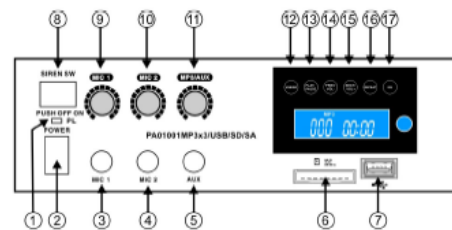

- | | |
|-------------------------|---|
| 1.Power Light | 11.MP3/AUX Volume Control |
| 2.Power Switch | 12.USB/SD Switch |
| 3.MIC-1 Phone Jack | 13.Play/pause Button |
| 4.MIC-2 Phone Jack | 14. Volume controls & previous (hold 2 sec the volume-) |
| 5.AUX Phone Jack | 15. Volume controls & next (hold 2 sec the volume-) |
| 6.SD MMC MS Port | 16.Repeat |
| 7.USB Port | 17.EQ Sound effect |
| 8.Siren Switch | |
| 9.MIC-1 Volume Control | |
| 10.MIC-2 Volume Control | |

www.lotronic.com

REAR PANEL

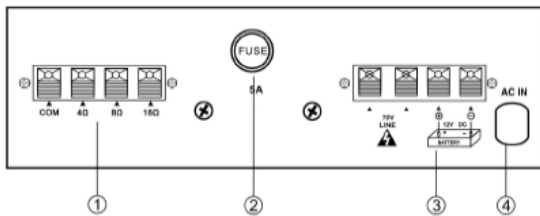

1. Speaker output, low & high impedance
2. AC FUSE
3. DC 12V battery
4. AC INPUT

EXAMPLE OF POSSIBLE CONNECTIONS

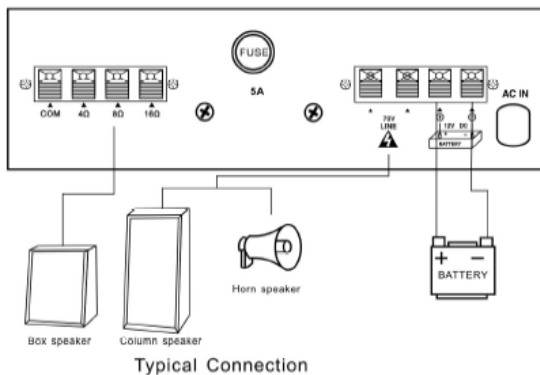

Nous vous remercions pour l'achat de cet amplificateur de puissance qui vous donnera des années de satisfaction.
Lire attentivement ce mode d'emploi avant utilisation et le conserver pour référence ultérieure.

CARACTERISTIQUES TECHNIQUES

Comporte un lecteur MP3, USB, SD avec les entrées suivantes :

- Lecteur MP3
- 1 port USB
- 1 port SD
- 2 entrées MICRO -42dB 10k Ω / 50k Ω
- 1 entrée AUX -20dB 10k Ω / 50k Ω

Puissance de sortie : 45W max., 35W RMS

THD : <3% à 1kHz

Impédance des haut-parleurs : 4 – 8 16Ω 70V

Bande passante : 150-15.000Hz

Alimentation : 110/220Vac, 12Vdc

FACADE

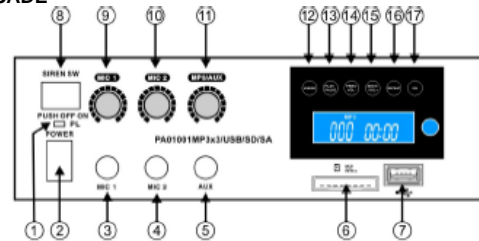

- | | |
|---|--|
| <ol style="list-style-type: none"> 1. Voyant de tension 2. Interrupteur M/A 3. Fiche MICRO 1 4. Fiche MICRO 2 5. Fiche AUX 6. Port SD MMC MS 7. Port USB 8. Sirène 9. Contrôle de volume MICRO 1 10. Contrôle de volume MICRO 2 | <ol style="list-style-type: none"> 11. Contrôle de volume MP3/AUX 12. Commutateur USB/SD 13. Touche de lecture/pause 14. Contrôle de volume & retour (maintenir Vol- enfoncé pendant 2 sec.) 15. Contrôle de volume & suivant (maintenir Vol+ enfoncé pendant 2 sec.) 16. Répétition 17. Egaliseur effets sonores |
|---|--|

ARRIERE

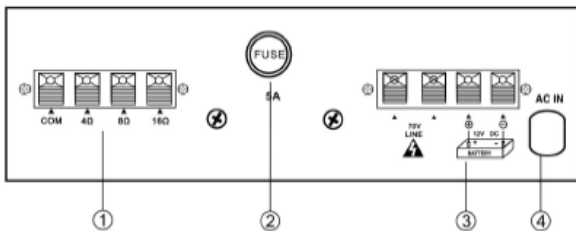

1. Sortie haut-parleur haute & basse impédance
2. Fusible AC
3. Batterie 12Vdc
4. Entrée AC

EXEMPLE DE CONNEXIONS POSSIBLES

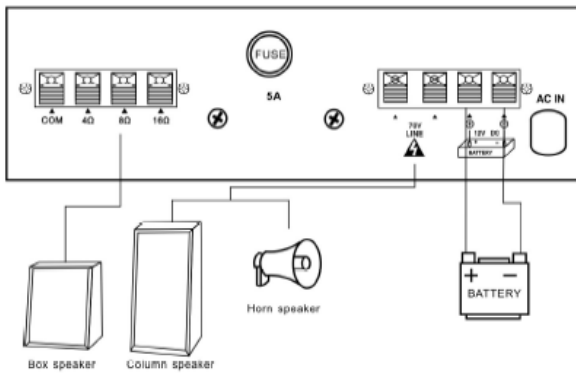

Branchement type

Wir danken Ihnen für den Kauf dieses Leistungsverstärkers. Bitte lesen Sie vor Inbetriebnahme sorgfältig die Anleitung durch und bewahren Sie sie für spätere Bezugnahme auf.

TECHNISCHE DATEN

Eingebauter MP3, USB, SD Spieler mit folgenden Eingängen:

- MP3 Spieler
- 1 USB Port
- 1 SD Port
- 2 Mikrofonbuchsen -42dB 10k Ω / 50k Ω
- 1 AUX Eingang -20dB 10k Ω / 50k Ω

Ausgangsleistung : 45W max., 35W RMS

THD : <3% bei 1kHz

Lautsprecherimpedanz : 4 – 8 16Ω 70V

Frequenzbereich: 150-15.000Hz

Versorgung: 110/220Vac, 12Vdc

Bedienelemente auf der FRONTSEITE

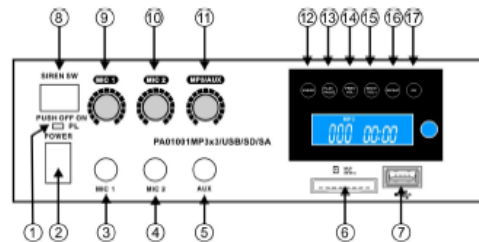

- | | |
|---|---|
| <ol style="list-style-type: none"> 1. Betriebsanzeige 2. Ein/Aus Schalter 3. MIKRO 1 Buchse 4. MIKRO 2 Buchse 5. AUX Buchse 6. SD MMC MS Port 7. USB Port 8. Sirene 9. MIKRO 1 Lautstärkereger | <ol style="list-style-type: none"> 11. MP3/AUX Lautstärkereger 12. USB/SD Schalter 13. Play/Pause Taste 14. Lautstärkereger & Zurück (Vol- 2 Sek. lang gedrückt halten) 15. Lautstärkereger & Weiter (Vol+ 2 Sek. lang gedrückt halten.) 16. Wiederholung 17. EQ Klangeffekt |
|---|---|

10. MIKRO 2 Lautstärkereger
RÜCKSEITE

PT

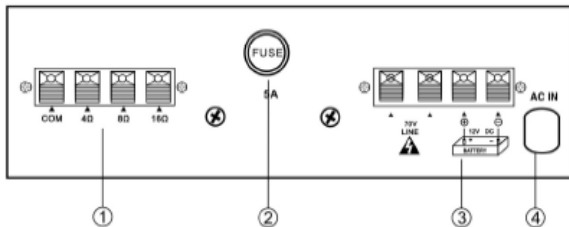

1. Lautsprecherausgang, hoch- & niederohmig
2. Netzsicherung
3. 12V DC Batterie
4. Netzeingang

BEISPIEL FÜR MÖGLICHE ANSCHLÜSSE

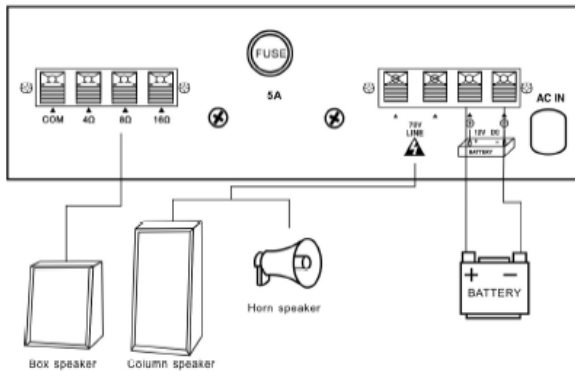

Typischer Anschluss

© Copyright Lotronic 2010

Obrigado por adquirir este amplificador de potência que lhe dará anos de satisfação.

Leia este manual antes de usar e guardar para referência futura.

ESPECIFICAÇÕES

Inclui leitor MP3, USB, SD:

- Leitor MP3
- 1 Porta USB
- 1 Porta SD
- 2 Entradas MICRO -42dB 10k Ω / 50k Ω
- 1 Entrada AUX -20dB 10k Ω / 50k Ω

Potência de Saída : 45W max., 35W RMS

THD : <3% a 1kHz

Impedância: 4 – 8 16Ω 70V

Frequência: 150-15.000Hz

Voltagem: 110/220Vac, 12Vdc

PAINEL FRONTAL

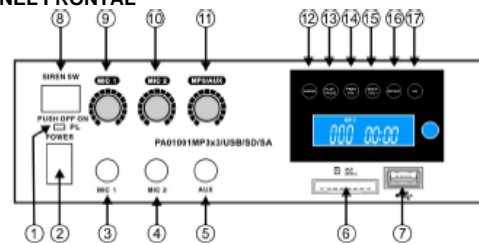

1. Luz de energia
2. Interruptor ON/OFF
3. Jack MICRO 1
4. Jack MICRO 2
5. Jack AUX
6. Porta SD MMC MS
7. Porta USB
8. Sirene
9. Controle de Volume MICRO 1

11. Controle de Volume MP3/AUX
12. Comutador USB/SD
13. Botão PLAY/PAUSE
14. Controle de volume e retorno (manter Vol- premido durante 2 seg.)
15. Controle de volume e avanço (manter Vol+ premido durante 2 seg.)
16. Repetição
17. Efeitos sonoros EQ

© Copyright Lotronic 2010

10. Controlo de Volume MICRO 2

PAINEL TRASEIRO

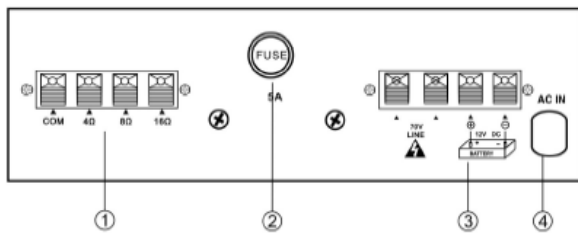

1. Saída para colunas, alta & baixa impedância
2. Fusível AC
3. Bateria 12Vdc
4. Entrada AC

LIGAÇÕES POSSÍVEIS

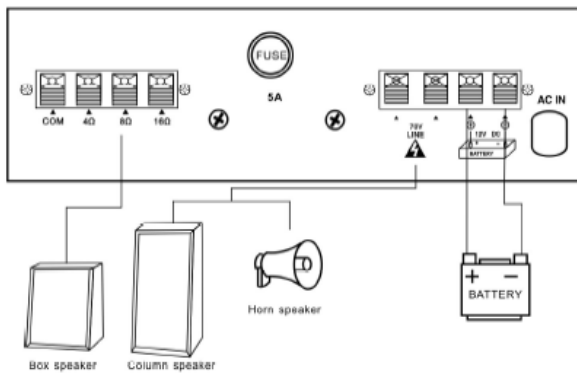

Ligações Típicas