



Visit product page



FOS HERCULES PRO

L005882

Multipurpose Profile and Beam/Spot/Wash (BSW) moving head , latest technology White 1000W LED light source, Total Output (Lumen) 35.000, 7000K color temperature, CRI 90Ra, lifetime 20.000 hours, Zoom range 5°-45°, variable High-precision glass lenses, electronic linear HD focus, 4-facet prism effect, 6 interchangeable variable speed rotation gobos , CW/CCW, 7 static gobos, linear CMY + CTO for infinity color mixing, framing system , frost effect, linear animation wheel .

TECHNICAL DETAILS

Light source / Optics

Light source: 1000 Watt white LED.

CRI \geq 90

Expected lifetime: 20,000 hours.

Colour temperature: 6500 Kelvin.

38000 lumens (max beam angle).

Zoom range 5°~45° Linear high speed zoom the spot is uniform and consistent in any range.

Focus: high precision glass lens, electron linear focus.

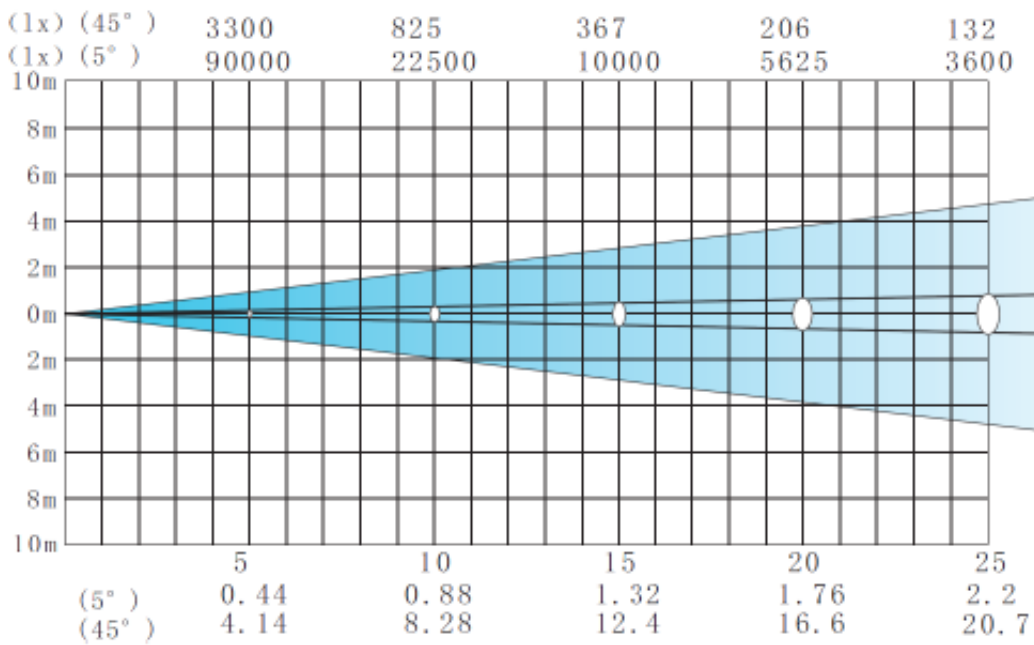

Effects

Prism: 1 four-prism.

Frost: 1-independent frost effect.

Rotating gobo wheel: 1 interchangeable gobo rotator, 6 optional pattern pieces.

Fixed gobo wheel: 1 fixed gobos +7 pattern pieces +open, CW/CCW rotation, variable speed.

Gobo outside diameter: 27mm.

Max. Image diameter: 22mm.

Max Thickness: 3.5mm.

Gobo material: high-temperature coated glass.

Color wheel: 6 color gel and open gobo, "Rainbow effect" in both directions.

CMY: infinite color mixing.

CTO: 6500K-2700K.

Pan/Tilt movement: 540°/270°adopting a function which resets 32bit accurately and automatically Strobe: 1-20Hz.

Dimmer: 0-100%, mechanical linear dimming.

Color wheel

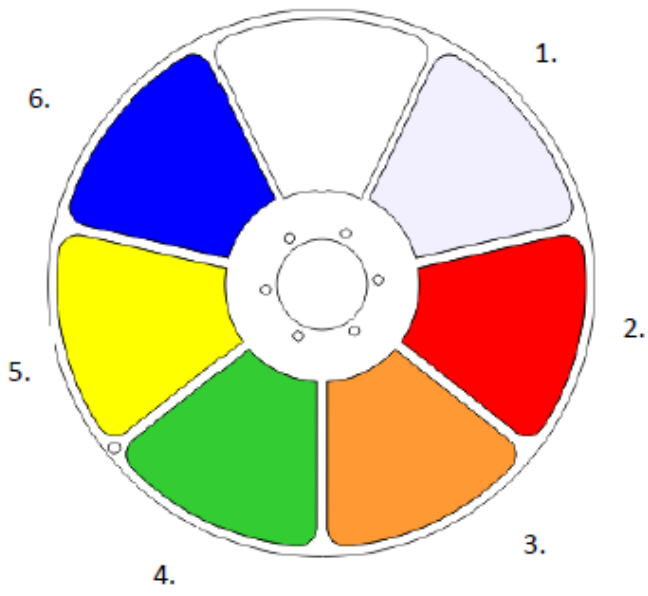

CMY/CTO

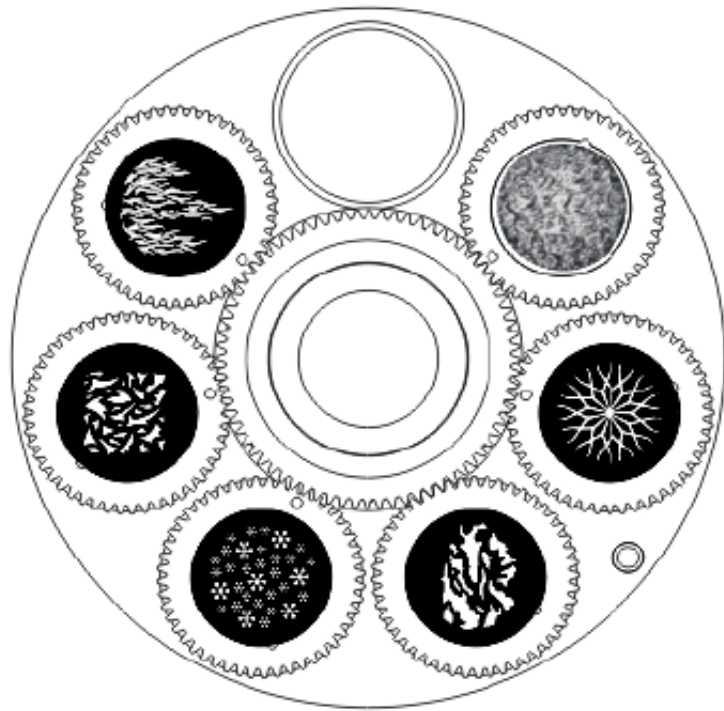
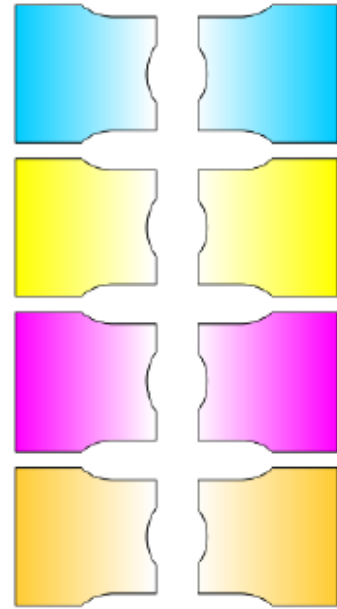

Rotating gobo wheel

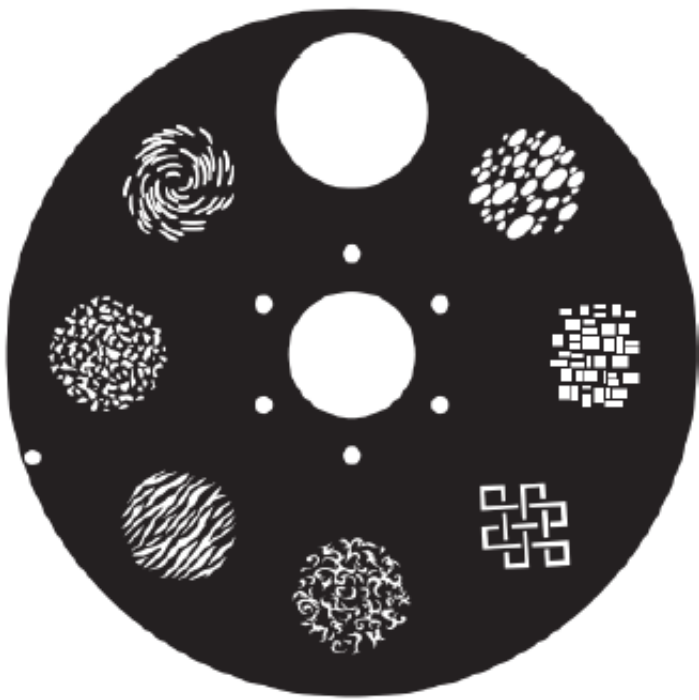

Fixed gobo wheel

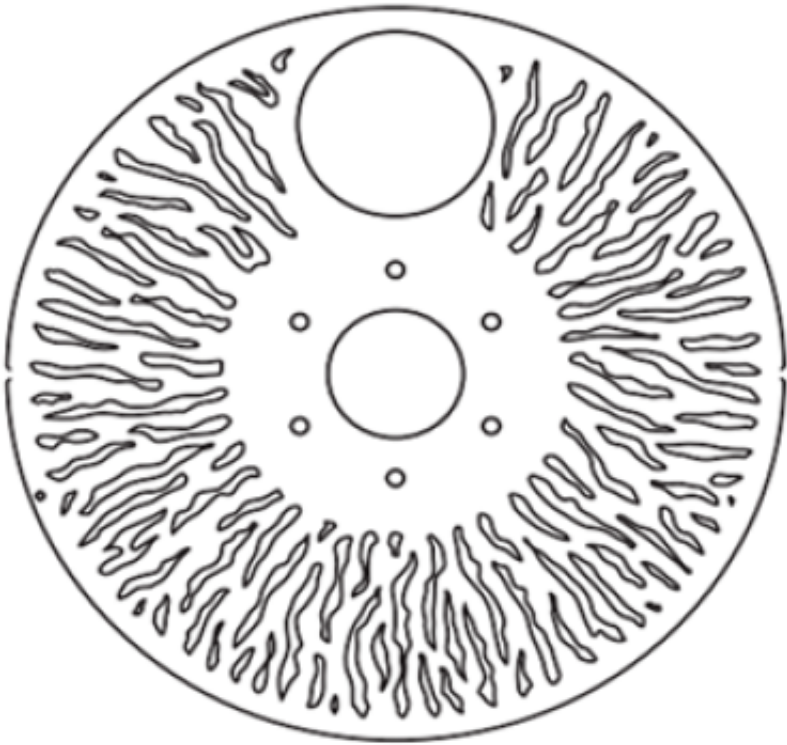

Effect gobo wheel

Control

Control channels (DMX): 36/33/52

Protocol: DMX-512 RDM

Display: OLED

Installation / Dimension details

Power input, nominal: AC 100-240V 50/60Hz.

Max. Power consumption: 1107W.

Max current: 11.15A PF: 0.99.

Main fuse: 250V / 15A.

Power input: self-contained power cord.

DMX data input/output: Chassis 3-pin.

Weight: 36.5kg.

IP rating: IP20.

Material: Aluminum, copper, steel, plastic, iron.

Mounting points: 4 fixed folding lamp hook + attachment points for safety wire.

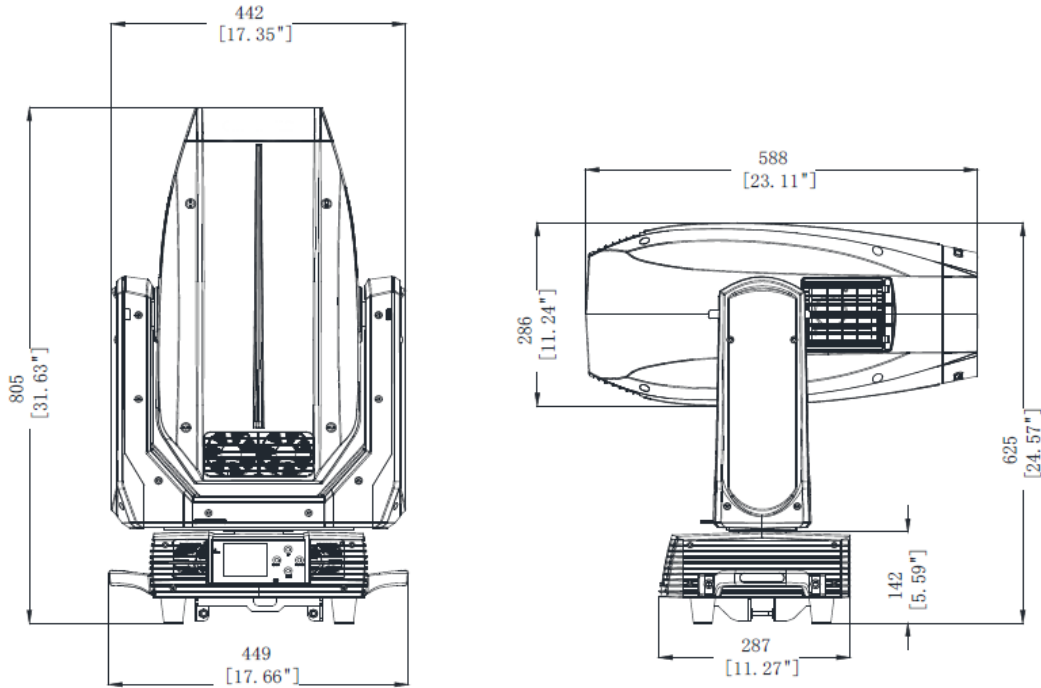

Thermal conditions

Operating range: 14°F to 113°F (-10°C to 45°C)

Startup range: -13°F to 113°F (-25°C to 45°C)

Storage range: -39.9°F to 140°F (-40°C to 60°C)

Cooling: Active fan

Humidity: ≤85%

Certifications and safety

EMC: EN 55103-1:2009, EN 55103-2:2009, EN 61000-3-2:2006+A2:2009, EN 61000-3-3:2013, GB/T 17743-2007, GB 17625.1-2012

Safety: EN 60598-2-17:1989/A2:1991, GB 7000.1-2015, GB 7000.217-2008

PHOTOS



PRODUCT VIDEO



www.fos-lighting.eu

