

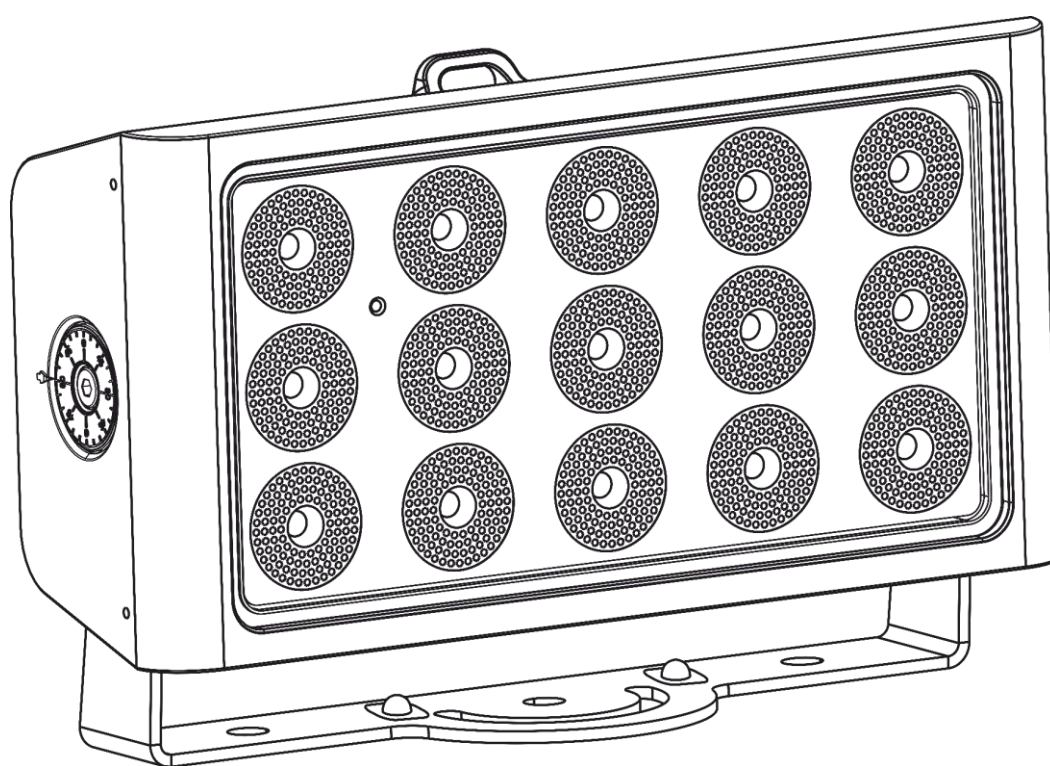

USER MANUAL



ENGLISH

Cameleon Flood 15 Q6 Tour V1

Product code: 42684

Preface

Thank you for purchasing this Showtec product.

The purpose of this user manual is to provide instructions for the correct and safe use of this product.

Keep the user manual for future reference as it is an integral part of the product. The user manual shall be stored at an easily accessible location.

This user manual contains information concerning:

- Safety instructions
- Installation and operation of the device
- Intended and non-intended use of the device
- Maintenance procedures
- Troubleshooting
- Transport, storage and disposal of the device

Non-observance of the instructions in this user manual may result in serious injuries and damage of property.

©2023 Showtec. All rights reserved.

No part of this document may be copied, published or otherwise reproduced without the prior written consent of Highlite International.

Design and product specifications are subject to change without prior notice.

For the latest version of this document or other language versions, please visit our website www.highlite.com or contact us at service@highlite.com.

Highlite International and its authorized service providers are not liable for any injury, damage, direct or indirect loss, consequential or economic loss or any other loss arising from the use of, or inability to use or reliance on the information contained in this document.

Table of contents

1. Introduction	4
1.1. Before Using the Product	4
1.2. Intended Use	4
1.3. Product Lifespan	4
1.4. LEDs Lifespan	4
1.5. Text Conventions	4
1.6. Symbols and Signal Words	5
1.7. Symbols on the Information Label	5
2. Safety	6
2.1. Warnings and Safety Instructions	6
2.2. Requirements for the User	8
3. Description of the Device	9
3.1. Front View	9
3.2. Back View	9
3.3. Product Specifications	10
3.4. Optional Accessories	10
3.5. Dimensions	11
4. Installation	12
4.1. Safety Instructions for Installation	12
4.2. Personal Protective Equipment	12
4.3. Installation Site Requirements	12
4.4. Rigging	13
4.4.1. Angle Adjustment	13
4.5. Connecting to Power Supply	14
4.6. Power Linking of Multiple Devices	14
5. Setup	15
5.1. Warnings and Precautions	15
5.2. Stand-alone Setup	15
5.3. DMX Connection	15
5.3.1. DMX-512 Protocol	15
5.3.2. DMX Cables	16
5.3.3. Master/Slave Setup	16
5.3.4. DMX Linking	17
5.3.5. DMX Addressing	17
6. Operation	18
6.1. Safety Instructions for Operation	18
6.2. Control Modes	18
6.3. Control Panel	19
6.4. Start-up	19
6.5. Menu Overview	20
6.6. Main Menu Options	22
6.6.1. DMX Settings	22
6.6.1.1. Address	23
6.6.1.2. Channels	23
6.6.2. Manual Mode	23
6.6.3. Auto	24
6.6.4. Program	24
6.6.4.1. Program 01	25
6.6.4.2. Programs 02–16	25
6.6.5. Master/Slave Mode	25
6.6.6. Settings	26
6.6.6.1. Curves Select	26
6.6.6.2. Dimmer Speed	27

- 6.6.6.3. DMX Fail.....27
- 6.6.6.4. DMX Sync27
- 6.6.6.5. Lock.....28
- 6.6.6.6. Factory28
- 6.6.7. Information28
- 6.7. DMX Channels29
 - 6.7.1. 6 Channels, 8 Channels, 12 Channels29
- 6.8. RDM Information.....31
 - 6.8.1. RDM Details.....31
 - 6.8.2. Supported RDM PIDs (Parameter IDs)31
 - 6.8.3. Highlite RDM Details31
- 6.9. Remote Control32
 - 6.9.1. Auto.....34
 - 6.9.2. Built-in Programs.....34
 - 6.9.2.1. Color Presets.....34
 - 6.9.2.2. Strobe34
 - 6.9.2.3. Program Speed35
 - 6.9.3. Manual35
- 7. Troubleshooting36**
- 8. Maintenance37**
 - 8.1. Safety Instructions for Maintenance.....37
 - 8.2. Preventive Maintenance37
 - 8.2.1. Basic Cleaning Instructions.....37
 - 8.2.2. Draining Condensation Water.....38
 - 8.3. Corrective Maintenance38
- 9. Deinstallation, Transportation and Storage39**
 - 9.1. Instructions for Deinstallation.....39
 - 9.2. Instructions for Transportation39
 - 9.3. Storage.....39
- 10. Disposal39**
- 11. Approval.....39**

1. Introduction

1.1. Before Using the Product



Important
Read and follow the instructions in this user manual before installing, operating or servicing this product.

The manufacturer will not accept liability for any resulting damages caused by the non-observance of this manual.

After unpacking, check the contents of the box. If any parts are missing or damaged, contact your Highlite International dealer.

Your shipment includes:

- Showtec Cameleon Flood 15 Q6 Tour
- Schuko to Power Pro True cable (1,5 m)
- Quick-lock bracket
- User manual

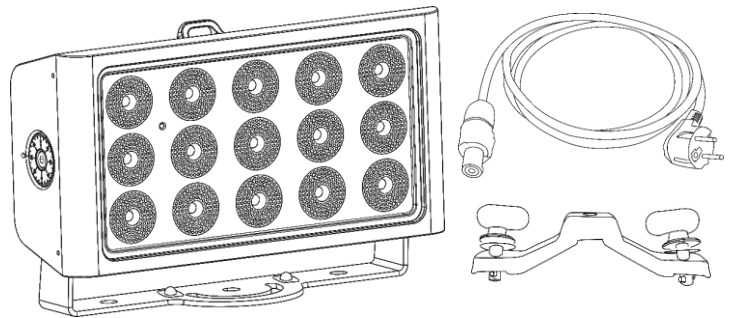

Fig. 01

1.2. Intended Use

This device is intended for professional use as a professional outdoor wall washer. It is not suitable for households and for general lighting.

Any other use, not mentioned under intended use, is regarded as non-intended and incorrect use.

1.3. Product Lifespan

This device is not designed for permanent operation. Disconnect the device from the electrical power supply when the device is not in operation. This will reduce the wear and will improve the device's lifespan.

1.4. LEDs Lifespan

The light output of the LEDs gradually decreases over time (lumen depreciation). High operating temperatures contribute to this process. You can extend the lifespan of the LEDs by providing adequate ventilation and operating the LEDs at the lowest possible brightness.

1.5. Text Conventions

Throughout the user manual the following text conventions are used:

- Buttons: All buttons are in bold lettering, for example "Press the **UP/DOWN** buttons"
- References: References to chapters and parts of the device are in bold lettering, for example: "Refer to **2. Safety**", "turn the **adjustment handle (05)**"
- 0–255: Defines a range of values
- Notes: **Note:** (in bold lettering) is followed by useful information or tips

1.6. Symbols and Signal Words

Safety notes and warnings are indicated throughout the user manual by safety signs.

Always follow the instructions provided in this user manual.



DANGER

Indicates an imminently hazardous situation which, if not avoided, will result in death or serious injury.



WARNING

Indicates a potentially hazardous situation which, if not avoided, could result in death or serious injury.



CAUTION

Indicates a potentially hazardous situation, which, if not avoided, may result in minor or moderate injury.



Attention

Indicates important information for the correct operation and use of the product.



Important

Read and observe the instructions in this document.



Electrical hazard



Eye damage hazard



Provides important information about the disposal of this product.



1.7. Symbols on the Information Label

This product is provided with an information label. The information label is located on the mounting bracket of the device.

The information label contains the following symbols:



This device shall not be treated as household waste.

IP65

This device is rated IP65.



This device falls under IEC protection class I.



Read the user manual supplied with the device.

2. Safety



Important
Read and follow the instructions in this user manual before installing, operating or servicing this product.

The manufacturer will not accept liability for any resulting damages caused by the non-observance of this manual.

2.1. Warnings and Safety Instructions



DANGER
Danger for children

For adult use only. The device must be installed beyond the reach of children.

- Do not leave various parts of the packaging (plastic bags, polystyrene foam, nails, etc.) within children's reach. Packaging material is a potential source of danger for children.



DANGER
Electric shock caused by dangerous voltage inside

There are areas within the device where dangerous touch voltage may be present.

- Do not open the device or remove any covers.
- Do not operate the device if the covers or the housing are open. Before operation, check if the housing is firmly closed and all screws are tightly fastened.
- Disconnect the device from electrical power supply before service and maintenance, and when the device is not in use.



DANGER
Electric shock caused by short-circuit

This device falls under IEC protection class I.

- Make sure that the device is electrically connected to ground (earth). Connect the device only to a socket-outlet with ground (earth) connection.
- Do not cover the ground (earth) connection.
- Do not bypass the thermostatic switch or fuses.
- Do not let the power cable come into contact with other cables. Handle the power cable and all connections with the mains with caution.
- Do not modify, bend, mechanically strain, put pressure on, pull or heat up the power cable.
- Make sure that the power cable is not crimped or damaged. Examine the power cable periodically for any defects.
- Do not immerse the device in water or other liquids. Do not install the device in a location where flooding may occur.
- Do not use the device during thunderstorms. Disconnect the device from the electrical power supply immediately.
- Keep the connectors sealed with the rubber caps when the connectors are not in use.
- Do not connect the cables from above the connectors, if the device is installed outdoors. Make a 'drip loop' in the cable so that rain water cannot enter the device.



WARNING
Risk of epileptic shock

Strobe lighting can trigger seizures in photosensitive epilepsy. Sensitive persons should avoid looking at strobe lights.



CAUTION
Possible eye damage caused by high light intensity

Possibly hazardous optical radiation emitted from this device.

- Do not look at the operating light source. May be harmful to the eye.
- Do not look at the light source with optical instruments that may concentrate the light output.
- Make sure that persons are not looking directly into the light source when the device lights up suddenly. This can happen when the device is powered or when it receives DMX signal, or when certain menu items are selected.
- Disconnect power supply before servicing.
- Wear protective goggles if looking into light source during service or maintenance.



Attention
Power supply

- Before connecting the device to the power supply, make sure that the current, voltage and frequency match the input voltage, current and frequency specified on the information label on the device.
- Make sure that the cross-sectional area of the extension cords and power cables is sufficient for the required power consumption of the device.



Attention
General safety

- Do not connect the device to a dimmer pack.
- Do not switch the device on and off in short intervals. This decreases the device's life.
- Do not shake the device. Avoid brute force when installing or operating the device.
- Change the lens or the LEDs if they are visibly damaged to such an extent that their effectiveness is impaired, for example by cracks or deep scratches. Contact your Highlite International dealer for more information, as servicing can be performed only by instructed or skilled persons.
- If the device is dropped or struck, disconnect the device from the electrical power supply immediately.
- If the device is exposed to extreme temperature variations (e.g. after transportation), do not switch it on immediately. Let the device reach room temperature before switching it on, otherwise it may be damaged by the formed condensation.
- If the device fails to work properly, discontinue the use immediately.



Attention
For professional use only
This device shall be used only for the purposes it is designed for.

This device is designed to be used as a professional outdoor wall washer. Any incorrect use may lead to hazardous situations and result in injuries and material damage.

- This device is not suitable for households and for general lighting.
- This device is not designed for permanent operation.
- This device does not contain user-serviceable parts. Unauthorized modifications to the device will render the warranty void. Such modifications may result in injuries and material damage.



Attention

Before each use, examine the device visually for any defects.

Make sure that:

- All screws used for installing the device or parts of the device are tightly fastened and are not corroded.
- The safety devices are not damaged.
- There are no deformations on housings, fixations and installation points.
- The lens is not cracked or damaged.
- The power cables are not damaged and do not show any material fatigue.



Attention

Do not expose the device to conditions that exceed the rated IP class conditions.

This device is IP65 rated. IP (Ingress Protection) 65 class means that the device is dust-tight and protected against harmful effect of water jets.

2.2. Requirements for the User

This product may be used by ordinary persons. Maintenance may be carried by ordinary persons. Installation and service shall be carried out only by instructed or skilled persons. Contact your Highlite International dealer for more information.

Instructed persons have been instructed and trained by a skilled person, or are supervised by a skilled person, for specific tasks and work activities associated with the installation, service and maintenance of this product, so that they can identify risks and take precautions to avoid them.

Skilled persons have training or experience, which enables them to recognize risks and to avoid hazards associated with the installation, service and maintenance of this product.

Ordinary persons are all persons other than instructed persons and skilled persons. Ordinary persons include not only users of the product but also any other persons that may have access to the device or who may be in the vicinity of the device.

3. Description of the Device

The Showtec Cameleon Flood 15 Q6 Tour is an IP65-rated outdoor wall washer. It is equipped with 15 x 10 W 6-in-1 RGBWA-UV LEDs.

3.1. Front View

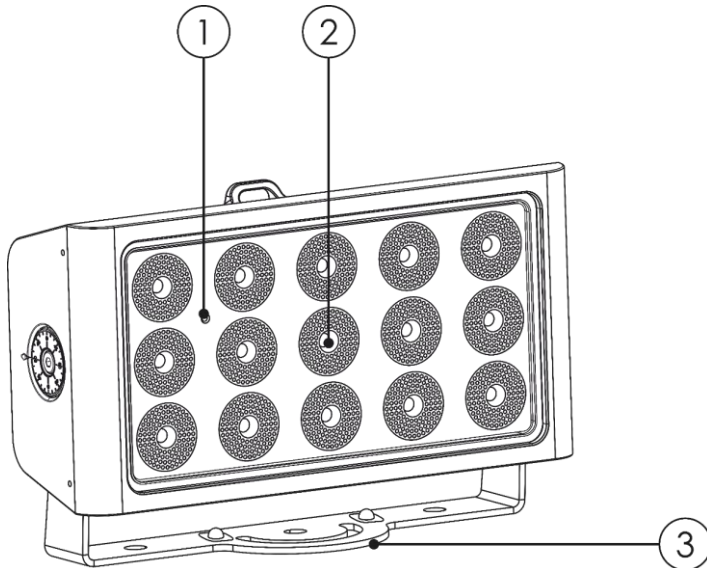

- 01) Infrared sensor
- 02) 15 x 10 W RGBWA-UV LEDs
- 03) Mounting bracket

Fig. 02

3.2. Back View

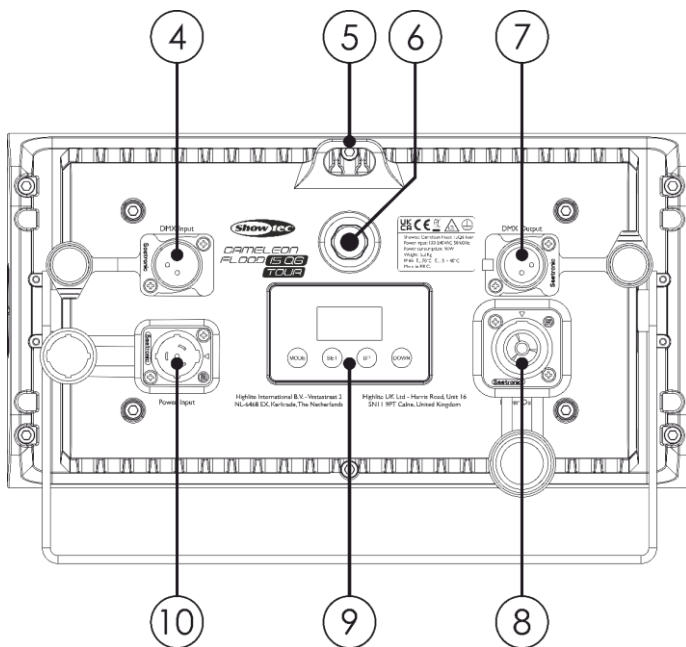

- 04) IP65-rated 3-pin DMX signal connector IN
- 05) Safety eye
- 06) Protective valve
- 07) IP65-rated 3-pin DMX signal connector OUT
- 08) IP65-rated Power Pro True connector OUT
- 09) OLED display and touch buttons
- 10) IP65-rated Power Pro True connector IN

Fig. 03

3.3. Product Specifications

Model:	Cameleon Flood 15 Q6 Tour	
Electrical:		
Input voltage:	100–240 V AC, 50/60 Hz	
Power consumption:	90 W	
Physical:		
Dimensions:	330 x 170 x 210 mm (L x W x H) (including bracket)	
Weight:	5,2 kg	
Optics:		
Light source:	15 x 10 W RGBWA-UV LEDs	
Light output:	3700 lm	
Dimmer:	0–100 %	
Strobe:	0–20 Hz	
Beam Angle Horizontal:	40°	
Beam Angle Vertical:	40°	
Refresh rate:	3000 Hz	
Operation and control:		
Control:	Manual, Auto, Built-in programs, Master/Slave, DMX-512, RDM, Remote	
DMX channels:	6, 8, 12 channels	
Control panel:	OLED display and touch buttons	
Connections:		
Power connections:	IP65-rated Power Pro True connectors IN/OUT	
Data connections:	IP65-rated 3-pin DMX connectors IN/OUT	
Signal pinouts:	Pin 1 (earth), pin 2 (-), pin 3 (+)	
Construction:		
Housing:	Die-cast aluminum	
Color:	Black	
IP rating:	IP65	
Cooling:	Convection	
Thermal:		
Minimum ambient temperature:	-5 °C	
Maximum ambient temperature t_a :	40 °C	
Maximum housing temperature t_c :	70 °C	
Minimum distance:		
Minimum distance from flammable surfaces:	1 m	
Minimum distance to lighted object:	0,5 m	

3.4. Optional Accessories

You can additionally purchase the following accessories:

Product code: [44002](#) (Showtec UR-5 Universal IR Remote)

3.5. Dimensions

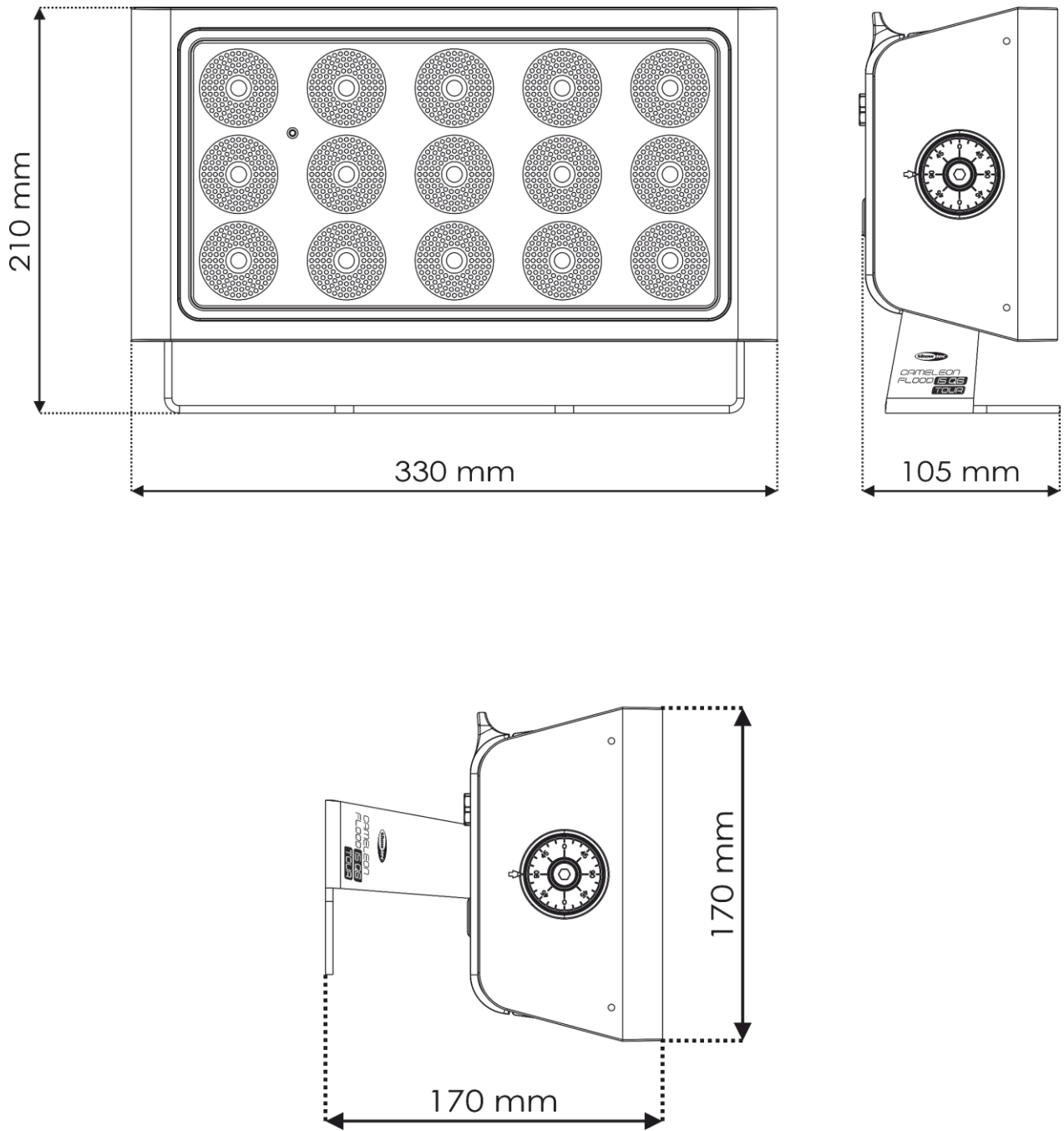

Fig. 04

4. Installation

4.1. Safety Instructions for Installation



WARNING

Incorrect installation can cause serious injuries and damage of property.

If trussing systems are used, installation must be carried out only by instructed or skilled persons.

Follow all applicable European, national and local safety regulations concerning rigging and trussing.

4.2. Personal Protective Equipment

During installation and rigging wear personal protective equipment in compliance with the national and site-specific regulations.

4.3. Installation Site Requirements

- The device can be used outdoors.
- The device can be mounted to a truss or other rigging structure.
- The minimum distance between the light output and the illuminated surface must be bigger than 0,5 m.
- The maximum ambient temperature $t_a = 40\text{ °C}$ must never be exceeded.
- The relative humidity must not exceed 50 % with an ambient temperature of 40 °C.

4.4. Rigging

The device can be positioned on a flat surface or mounted to a truss or other rigging structure. Make sure that all loads are within the pre-determined limits of the supporting structure.



CAUTION

Restrict the access under the work area during rigging and/or derigging.

To mount the device, follow the steps below:

- 01) Use a clamp to attach the device to the supporting structure, as shown in Fig. 05. Make sure that the device cannot move freely. The use of a quick lock bracket is optional.
- 02) Secure the device with a secondary suspension, for example a safety cable. Make sure that the secondary suspension can hold 10 times the weight of the device. If possible, the secondary suspension should be attached to a supporting structure independent of the primary suspension. Put the safety cable through the **safety eye (05)**, as shown in Fig. 05.

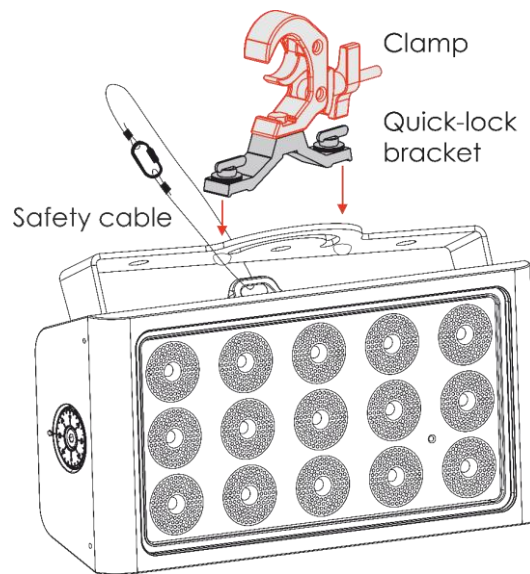

Fig. 05

4.4.1. Angle Adjustment

You can adjust the angle of the device.

Tilt the device to the desired angle (see Fig. 06). The tilt range is <math><180^\circ</math>.

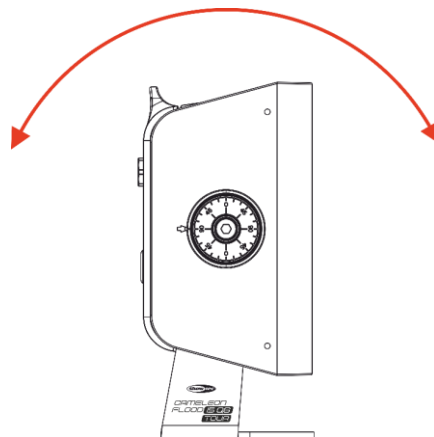

Fig. 06

4.5. Connecting to Power Supply



DANGER
Electric shock caused by short-circuit

The device accepts AC mains power at 100–240 V and 50/60 Hz. Do not supply power at any other voltage or frequency to the device.

This device falls under IEC protection class I. Make sure that the device is always electrically connected to the ground (earth).

Before connecting the device to the socket-outlet:

- Make sure that the power supply matches the input voltage specified on the information label on the device.
- Make sure that the socket-outlet has ground (earth) connection.

Connect the device to the socket-outlet with the power plug. Do not connect the device to a dimmer circuit, as this may damage the device.

This device is IP65 rated.

- Do not expose the device to conditions that exceed the rated IP class conditions.
- Keep the connectors sealed with the rubber caps when the connectors are not in use.
- Do not connect the cables from above the connectors, if the device is installed outdoors. Make a 'drip loop' in the cable so that rain water cannot enter the device.
- Make sure that the cable run is not too heavy. A heavy cable run can cause damage to the connectors. If the connectors are damaged, their ingress protection (IP) can deteriorate.

4.6. Power Linking of Multiple Devices

This device supports power linking. Power can be relayed to another device via the power OUT connector. Note that the input and the output connectors have different designs: one type cannot be connected to the other.

Power linking of multiple devices must be carried out only by instructed or skilled persons.



WARNING
Incorrect power linking may lead to overload of the electrical circuit and result in serious injuries and damage of property.

To prevent overload of the electrical circuit, when power linking multiple devices:

- Use cables with sufficient current-carrying capacity. The power cable supplied with the device is not suitable for power linking of multiple devices.
- Make sure that the total current draw of the device and all connected devices does not exceed the rated capacity of the power cables and the circuit breaker.
- Do not link more devices on one power link than the maximum recommended number.

Maximum recommended number of devices:

- at 100–120 V: 17 devices
- at 200–240 V: 34 devices

5. Setup

5.1. Warnings and Precautions



DANGER
Electric shock caused by short-circuit

This device is IP65 rated.

- Do not expose the device to conditions that exceed the rated IP class conditions.
- Keep the connectors sealed with the rubber caps when the connectors are not in use.
- Do not connect the cables from above the connectors, if the device is installed outdoors. Make a 'drip loop' in the cable so that rain water cannot enter the device.
- Make sure that the cable run is not too heavy. A heavy cable run can cause damage to the connectors. If the connectors are damaged, their ingress protection (IP) can deteriorate.



Attention
Connect all data cables before supplying power.
Disconnect power supply before connecting or disconnecting data cables.

5.2. Stand-alone Setup

When the Cameleon Flood 15 Q6 Tour is not connected to a controller or to other devices, it functions as a stand-alone device.

For more information about the control modes, refer to **6.2. Control Modes** on page 18.

5.3. DMX Connection

5.3.1. DMX-512 Protocol

You need a DMX serial data link to run light shows of one or more devices using a DMX-512 controller or to run synchronized shows of two or more devices set in a master/slave control mode.

The Cameleon Flood 15 Q6 Tour has 3-pin DMX signal IN and OUT connectors.

The pin assignment is as follows: pin 1 (ground), pin 2 (-), pin 3 (+).

Devices on a serial data link must be daisy-chained in a single line. The number of devices that you can control on one data link is limited by the combined number of the DMX channels of the connected devices and the 512 channels available in one DMX universe.

To comply with the TIA-485 standard, no more than 32 devices should be connected on one data link. In order to connect more than 32 devices on one data link, you must use a DMX optically isolated splitter/booster, otherwise this may result in deterioration of the DMX signal.

Note:

- Maximum recommended DMX data link distance: 300 m
- Maximum recommended number of devices on a DMX data link: 32 devices

5.3.2. DMX Cables

Shielded twisted-pair cables with 3-pin XLR connectors must be used for reliable DMX connection. You can purchase DMX cables directly from your Highlite International dealer or make your own cables.

If you use XLR audio cables for DMX data transmission, this may lead to signal degradation and unreliable operation of the DMX network.

When you make your own DMX cables, make sure that you connect the pins and wires correctly as shown in Fig. 07.

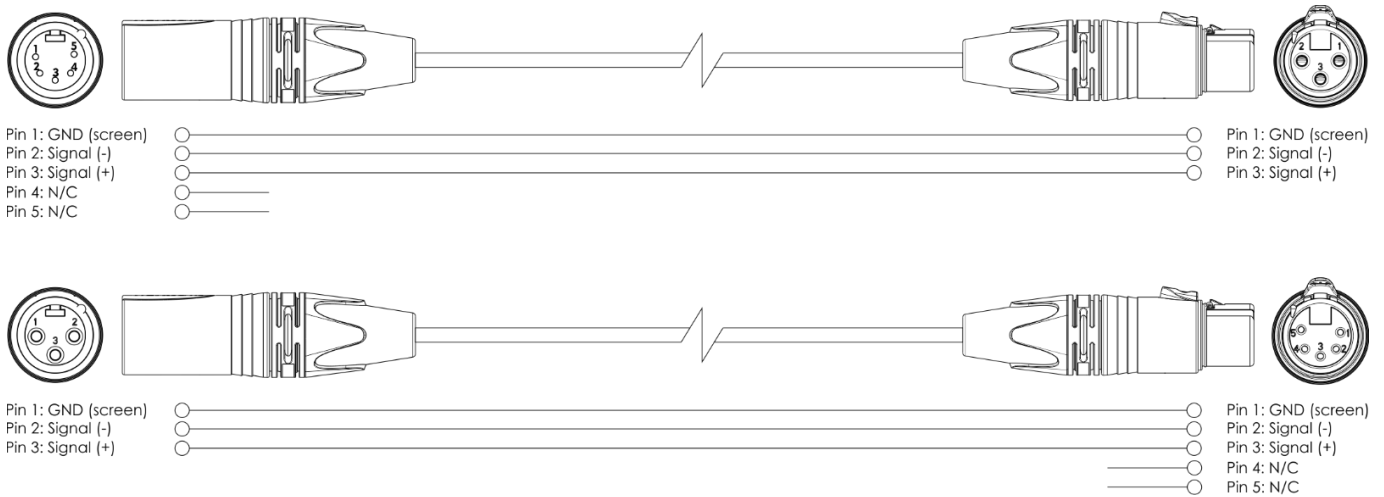

Fig. 07

5.3.3. Master/Slave Setup

The Cameleon Flood 15 Q6 supports master/slave control mode. To connect multiple devices in a master/slave setup, follow the steps below:

- 01) Connect the first device's DMX OUT connector to the second device's DMX IN connector.
- 02) Repeat step 1 to connect all devices as shown in Fig. 08.
- 03) Connect a DMX terminator (120 Ω resistor) to the DMX OUT connector of the last device in the setup.
- 04) Set the first device on the data link as a master device. See **6.6.5. Master/Slave Mode** on page 25 for more information.
- 05) Set the remaining devices to slave mode. See **6.6.5. Master/Slave Mode** on page 25 for more information.

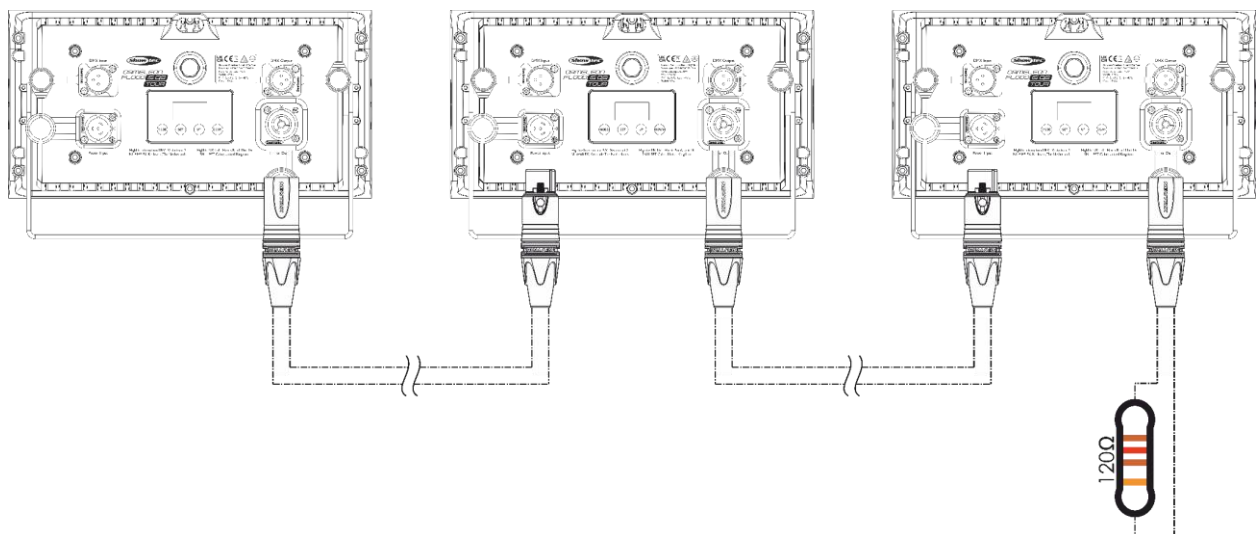

Fig. 08

5.3.4. DMX Linking

To connect multiple devices on one DMX data link, follow the steps below:

- 01) Use a 3-pin DMX cable to connect the DMX OUT connector of the lighting controller to the DMX IN connector of the first device.
- 02) Connect the first device's DMX OUT connector to the second device's DMX IN connector with a 3-pin DMX cable.
- 03) Repeat step 2 to connect all devices in a daisy-chain as shown in Fig. 09.
- 04) Connect a DMX terminator (120 Ω resistor) to the DMX OUT connector of the last device on the data link.

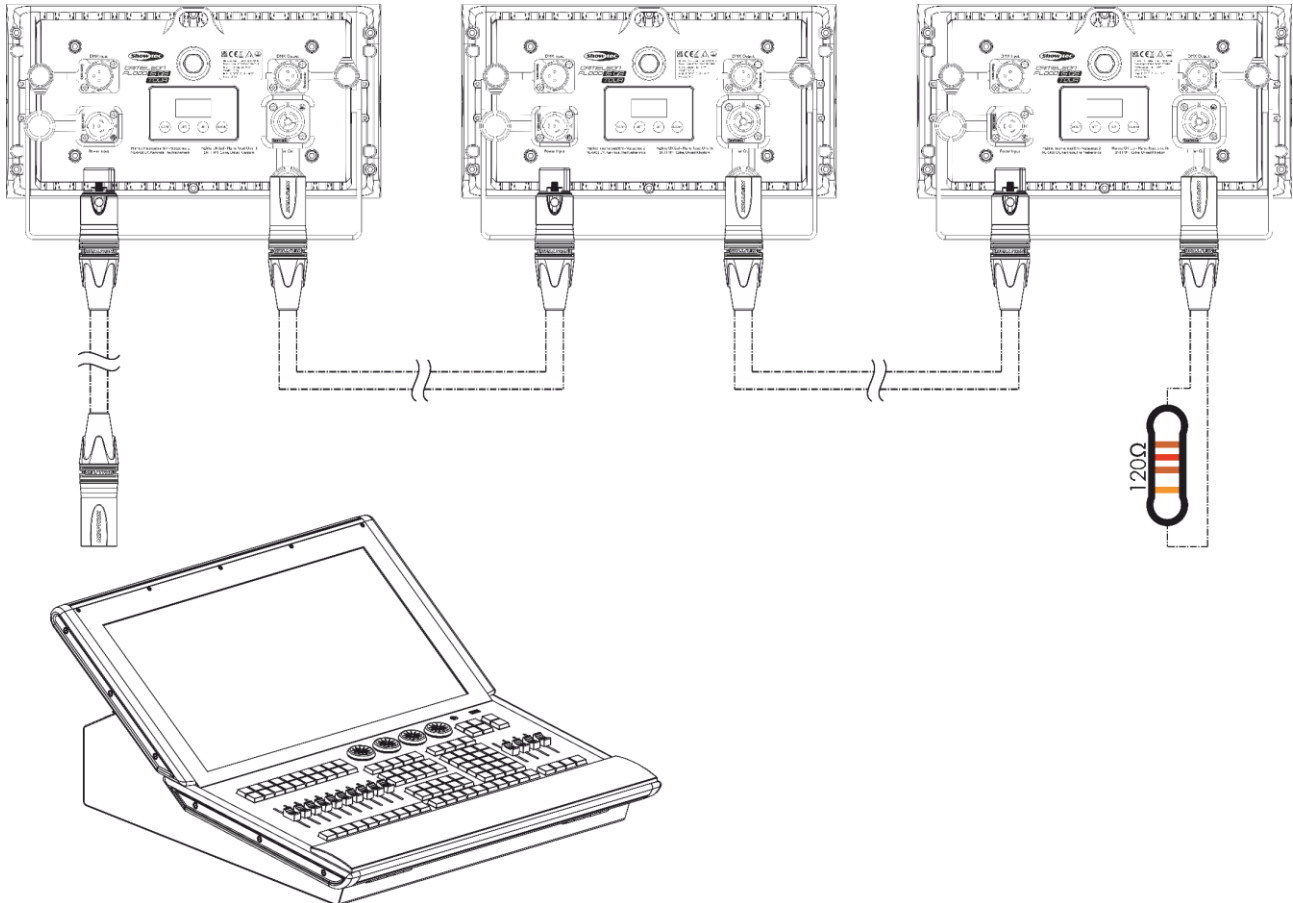

Fig. 09

5.3.5. DMX Addressing

In a setup with multiple devices, make sure that you set the DMX starting address of each device correctly. The Cameleon Flood 15 Q6 Tour has 3 personalities: 6, 8 or 12 channels.

If you want to connect multiple devices on one data link and use them in 12-channel mode, for example, follow the steps below:

- 01) Set the starting address of the 1st device on the data link to 1 (001).
- 02) Set the starting address of the 2nd device on the data link to 13 (013), as $1 + 12 = 13$.
- 03) Set the starting address of the 3rd device on the data link to 25 (025), as $13 + 12 = 25$.
- 04) Continue assigning the starting addresses of the remaining devices by adding each time 12 to the previous number.

Make sure that you do not have any overlapping channels in order to control the Cameleon Flood 15 Q6 Tour correctly. If two or more devices are addressed similarly, they will work similarly.

6. Operation

6.1. Safety Instructions for Operation



Attention

This device must be used only for the purposes it is designed for.

This device is intended for professional use as an outdoor wall washer. It is not suitable for households and for general lighting.

Any other use, not mentioned under intended use, is regarded as non-intended and incorrect use.



Attention

Power supply

Before connecting the device to the power supply, make sure that the current, voltage and frequency match the input voltage, current and frequency specified on the information label on the device.

6.2. Control Modes

The Cameleon Flood 15 Q6 Tour can be operated with a DMX controller, or without a DMX controller as a stand-alone device or in a master/slave setup.

The Cameleon Flood 15 Q6 Tour supports the following control modes:

- Stand-alone: Manual, Auto, Built-in programs
- Master/Slave: Manual, Auto, Built-in programs
- DMX-512, RDM 6, 8, 12 channels

For more information about how to connect the devices, refer to **5. Setup** on pages 15–17.

To operate the device manually as a stand-alone device or in a master/slave setup:

- Adjust the colors in Manual menu. See **6.6.2. Manual Mode** on page 24 for more information.

To run the built-in programs without a DMX controller:

- 01) Select one of the 16 built-in programs in Program menu. See **6.6.4. Program** on page 24 for more information. Adjust the program speed and strobe frequency.
- 02) Run all built-in programs in a sequence in Auto menu. See **6.6.3. Auto** on page 24 for more information.

To run the preset colors without a DMX controller:

Select one of the 33 preset colors in Program menu. See **6.6.4.1. Program 01** on page 25 for more information.

To operate the device with a DMX controller:

- 01) Set the DMX starting address of the device in Address menu. See **5.3.5. DMX Addressing** on page 17 and **6.6.1.1. Address** on page 23.
- 02) Select the DMX channel mode. See **6.6.1.2. Channels** on page 23 for more information. See **6.7. DMX Channels** on pages 29–30 for complete overview of all DMX channels.

6.3. Control Panel

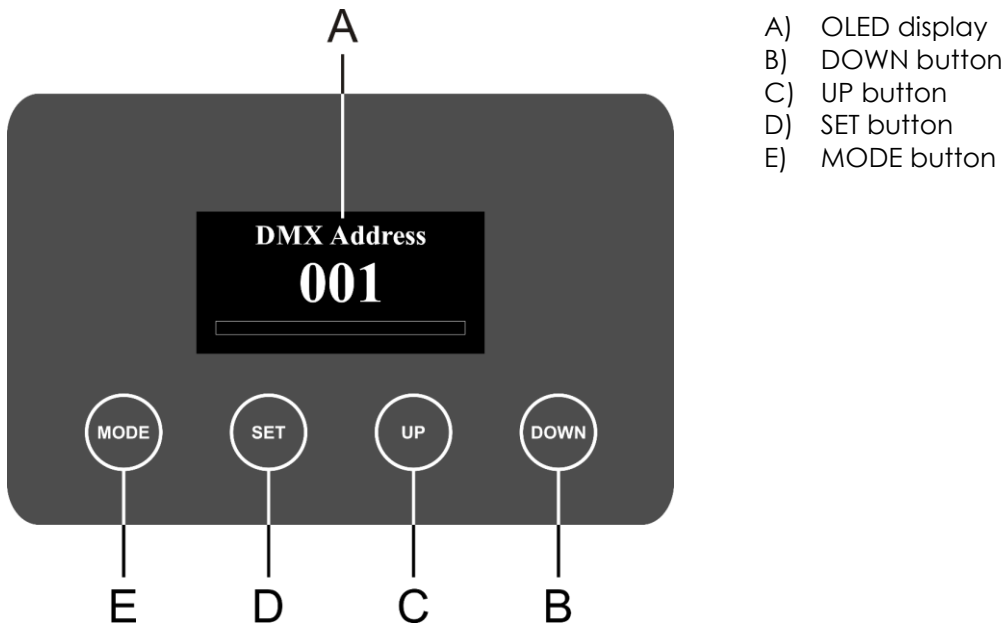

Fig. 10

- Use the **MODE** button to exit the current submenu and to return to the Main Menu.
- Use the **UP/DOWN** buttons to navigate through the menus or to increase/decrease numeric values.
- Use the **SET** button to open the desired menu, to confirm your choice or to set the currently selected value.

6.4. Start-up

Upon start-up the display will briefly show its software version and current temperature.

Note:

If no button is touched after 30 seconds of inactivity, the display will show the start screen: Touch any button to return to the main menu.

By default the display is locked. To access the main menu, you need to enter the **password**. Touch and hold the **MODE** and **SET** buttons for 3 seconds to unlock the display. See **6.6.6.5. Lock** on page 28 for more information.

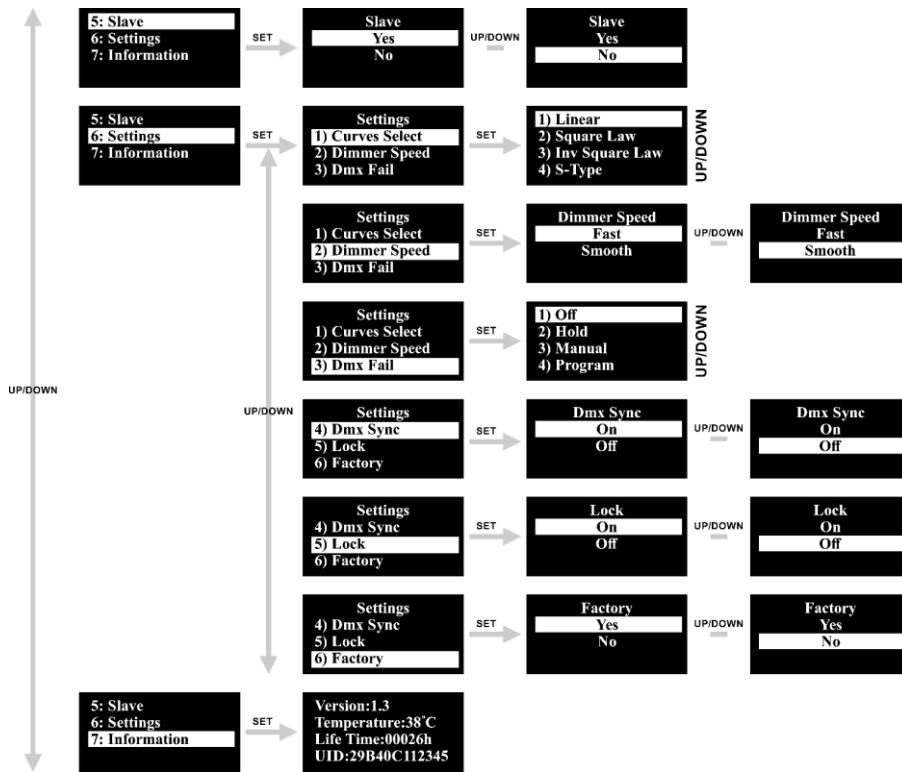

6.6. Main Menu Options

Upon start-up, the display will show the current software version and the temperature.



Version:1.3
Temperature:38°C

The main menu has the following options:

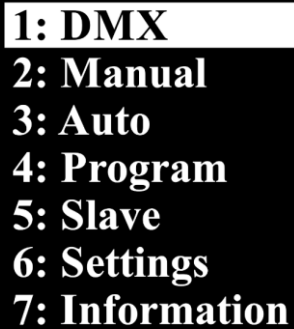

1: DMX
2: Manual
3: Auto
4: Program
5: Slave
6: Settings
7: Information

- Touch the **UP/DOWN** buttons to navigate through the main menu.
- Touch the **SET** button to open the submenus.

Note:

By default the display is locked. To access the main menu, you need to enter the **password**. Press and hold down the **MODE** and **SET** buttons for 3 seconds to unlock the display. See **6.6.6.5 Lock** on page 28 for more information.

6.6.1. DMX Settings

In this menu you can set the DMX address and choose the desired DMX channel mode.

- 01) While in the main menu, touch the **UP/DOWN** buttons to choose DMX.
- 02) Touch the **SET** button to enter the menu. The display will show:



DMX
1) Address 001
2) Channels: 06

- 03) Touch the **UP/DOWN** buttons to select one of the 2 submenus:
 - ADDRESS
 - CHANNELS
- 04) Touch the **SET** button to open the desired submenu.

6.6.1.1. Address

In this menu you can set the desired DMX starting address.



- 01) Touch the **UP/DOWN** buttons to set the desired DMX address. The adjustment range is 001–512.
- 02) Touch the **SET** button to confirm your choice.

6.6.1.2. Channels

In this menu you can set the desired DMX channel mode.



- 01) Touch the **UP/DOWN** buttons to set the desired DMX channel mode. Choose one of the 3 options:
 - 6 channels
 - 8 channels
 - 12 channels
- 02) Touch the **SET** button to confirm your choice.

6.6.2. Manual Mode

In this menu you can manually set the desired colors.

- 01) While in the main menu, touch the **UP/DOWN** buttons to choose MANUAL.
- 02) Touch the **SET** button to enter the menu. The display will show:

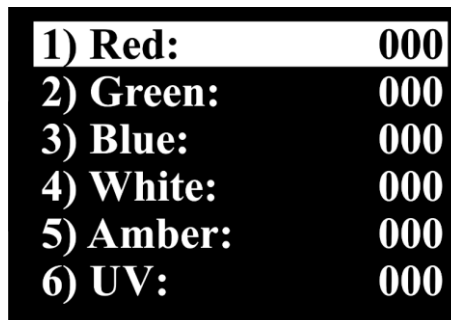

- 03) Touch the **UP/DOWN** buttons to choose one of the 6 colors: Red, Green, Blue, White, Amber and UV.
- 04) Touch the **SET** button to enter the menu.
- 05) Touch the **UP/DOWN** buttons to set the LED brightness. The adjustment range for each color is 0–255, from dark to brightest.
- 06) Touch the **SET** button to save your settings. You can combine Red, Green, Blue, White, Amber and UV to create an infinite range of colors (0–255).

6.6.3. Auto

In this menu you can set Auto mode.

- 01) While in the main menu, touch the **UP/DOWN** buttons to choose AUTO.
- 02) Touch the **SET** button to enter the menu. The display will show:

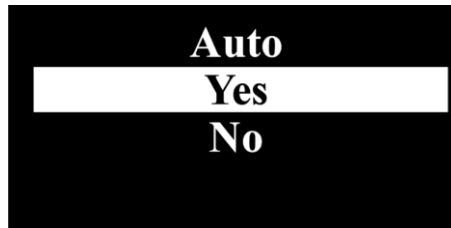

- 03) Touch the **UP/DOWN** buttons to choose YES (to start the auto show) or NO (to return to the previous screen).
- 04) Touch the **SET** button to confirm your choice.

6.6.4. Program

In this menu you can set the built-in programs and color presets.

- 01) While in the main menu, touch the **UP/DOWN** buttons to choose PROGRAM.
- 02) Touch the **SET** button to enter the menu. The display will show:

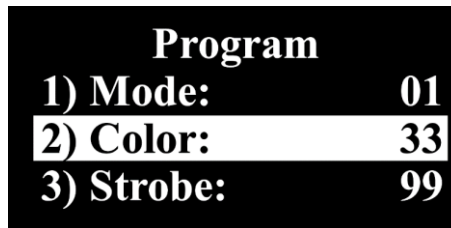

- 03) Touch the **UP/DOWN** buttons to choose MODE and touch the **SET** button to enter the menu. The display will show:



- 04) Touch the **UP/DOWN** buttons to choose one of the 16 built-in programs. Touch the **SET** button to confirm your choice.

6.6.4.1. Program 01

01) If you choose program 01, the display will show:

Program	
1) Mode:	01
2) Color:	33
3) Strobe:	99

- 02) Touch the **UP/DOWN** buttons to choose one of the 2 options:
- COLOR
 - STROBE
- 03) Touch the **SET** button to enter the desired menu.
- 04) If you chose COLOR, touch the **UP/DOWN** buttons to choose one of the 33 color macros. Touch the **SET** button to save your settings.
- 05) If you chose STROBE, touch the **UP/DOWN** buttons to set the strobe frequency. The adjustment range is between 0–99, from OFF to high frequency. Touch the **SET** button to save your settings.

6.6.4.2. Programs 02–16

01) If you choose one of the programs 02–16, the display will show:

Program	
1) Mode:	16
2) Speed:	100
3) Strobe:	99

- 02) Touch the **UP/DOWN** buttons to choose one of the 2 options:
- SPEED
 - STROBE
- 03) Touch the **SET** button to enter the desired menu.
- 04) If you chose SPEED, touch the **UP/DOWN** buttons to set the built-in program's speed. The adjustment range is 1–100, from slow to fast. Touch the **SET** button to save your settings.
- 05) If you chose STROBE, touch the **UP/DOWN** buttons to set the strobe frequency. The adjustment range is 0–99, from OFF to high frequency. Touch the **SET** button to save your settings.

6.6.5. Master/Slave Mode

In this menu you can set the device as a slave.

- 01) While in the main menu, touch the **UP/DOWN** buttons to choose SLAVE.
- 02) Touch the **SET** button to enter the menu. The display will show:

Slave	
Yes	
No	

- 03) Touch the **UP/DOWN** buttons to choose YES or NO.
- 04) Touch the **SET** button to confirm your choice.
- 05) If you have chosen YES, the device will be set as a slave and will react the same as the master device.

6.6.6. Settings

In this menu you can adjust the device's settings.

- 01) While in the main menu, touch the **UP/DOWN** buttons to choose SETTINGS.
- 02) Touch the **SET** button to enter the menu. The display will show:

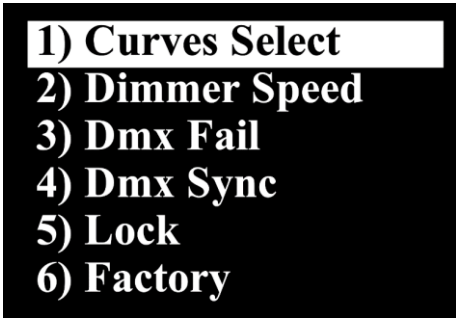

- 03) Touch the **UP/DOWN** buttons to choose one of the 6 submenus:
 - CURVES SELECT
 - DIMMER SPEED
 - DMX FAIL
 - DMX SYNC
 - LOCK
 - FACTORY
- 04) Touch the **SET** button to enter the desired submenu.

6.6.6.1. Curves Select

In this menu you can set the dimming curves.

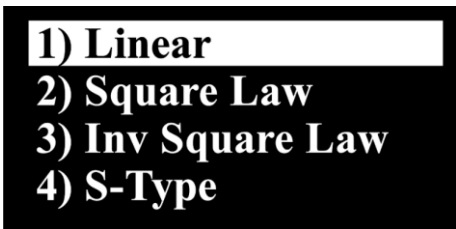

- 01) Touch the **UP/DOWN** buttons to choose one of the 4 dimming curves.
- 02) Touch the **SET** button to confirm your choice.

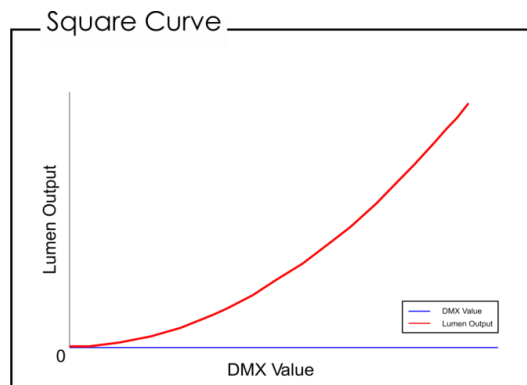
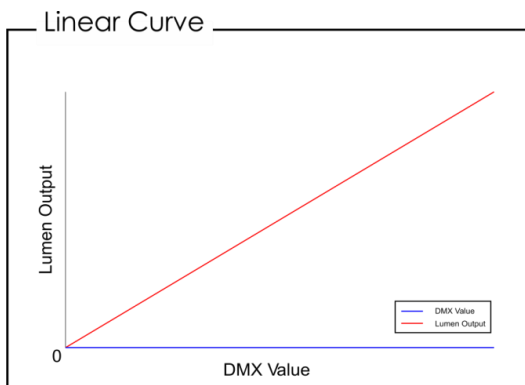

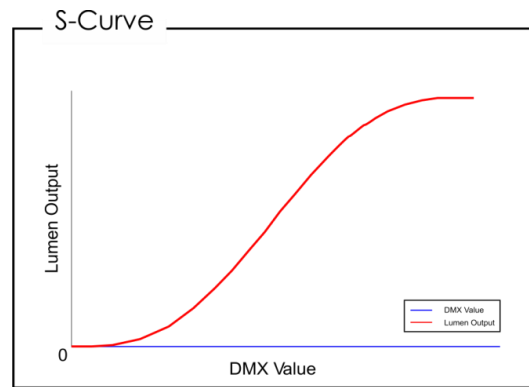
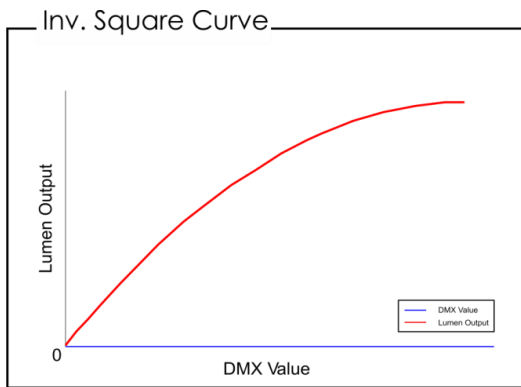

6.6.6.2. Dimmer Speed

In this menu you can set the dimmer speed.



- 01) Touch the **UP/DOWN** buttons to select FAST or SMOOTH.
- 02) Touch the **SET** button to confirm your choice.

6.6.6.3. DMX Fail

In this menu you can set the device's behavior in case of a DMX failure.

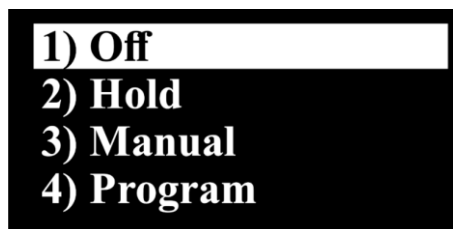

- 01) Touch the **UP/DOWN** buttons to select one of the 4 options:
 - OFF: the device will black out the light output
 - HOLD: the device will use last properly received DMX signal, ensuring uninterrupted performance
 - MANUAL: the device will switch to Manual mode
 - PROGRAM: the device will run the built-in programs
- 02) Touch the **SET** button to confirm your choice.

6.6.6.4. DMX Sync

In this menu you can set the devices' behavior, while using multiple Cameleons.

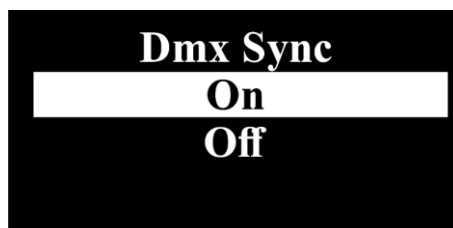

- 01) Touch the **UP/DOWN** buttons to select ON (all Cameleons will simultaneously perform the same action, without any delays) or OFF (risk of random delays).
- 02) Touch the **SET** button to confirm your choice.

6.6.6.5. Lock

In this menu you can set the safety lock, restricting access to the main menu.



- 01) Touch the **UP/DOWN** buttons to select one of the 2 options:
 - ON: when no button is pressed within 30 seconds, the device's main menu will be locked.
In order to unlock it, press and hold down the MODE and SET buttons for 3 seconds.
 - OFF: safety lock is inactive
- 02) Touch the **SET** button to confirm your choice.

6.6.6.6. Factory

In this menu you can restore the default factory settings.



- 01) Touch the **UP/DOWN** buttons to select YES or NO.
- 02) Touch the **SET** button to confirm your choice.

6.6.7. Information

In this menu you can view the device's current software version, temperature, total lifetime and the UID (device's RDM code).

- 01) While in the main menu, touch the **UP/DOWN** buttons to choose INFORMATION.
- 02) Touch the **SET** button to enter the menu. The display will show:



The device's RDM code is: 29B4:0C1xxxxx.

6.7. DMX Channels

6.7.1. 6 Channels, 8 Channels, 12 Channels

6 CH	8 CH	12 CH	Function	Value	Setting
	1	1	Master Dimmer	000–255	From low to high intensity (0–100 %)
	2	2	Linear Strobe	000–010	No function
				011–255	From low to high frequency (0–15 Hz)
		3	Pulse Strobe	000–010	No function
				011–255	From low to high frequency (0–15 Hz)
1	3		Red	000–255	From low to high intensity (0–100 %)
2	4		Green	000–255	From low to high intensity (0–100 %)
3	5		Blue	000–255	From low to high intensity (0–100 %)
4	6		White	000–255	From low to high intensity (0–100 %)
5	7		Amber	000–255	From low to high intensity (0–100 %)
6	8		UV	000–255	From low to high intensity (0–100 %)
		4	Color Presets	000–007	No function
				008–013	Color 1 R 255; G 000; B 000; W 000 A 000 U 000
				014–020	Color 2 R 255; G 000; B 000; W 100 A 000 U 000
				021–027	Color 3 R 255; G 000; B 000; W 200 A 000 U 000
				028–034	Color 4 R 255; G 050; B 000; W 000 A 000 U 000
				035–041	Color 5 R 000; G 000; B 000; W 000 A 255 U 000
				042–048	Color 6 R 255; G 255; B 000; W 000 A 000 U 000
				049–055	Color 7 R 255; G 255; B 000; W 075 A 000 U 000
				056–062	Color 8 R 000; G 255; B 000; W 255 A 000 U 000
				063–069	Color 9 R 000; G 255; B 000; W 150 A 000 U 000
				070–076	Color 10 R 000; G 255; B 000; W 050 A 000 U 000
				077–083	Color 11 R 000; G 255; B 000; W 000 A 000 U 000
				084–090	Color 12 R 000; G 255; B 050; W 000 A 000 U 000
				091–097	Color 13 R 000; G 255; B 150; W 000 A 000 U 000
				098–104	Color 14 R 000; G 255; B 255; W 000 A 000 U 000
				105–111	Color 15 R 000; G 255; B 255; W 075 A 000 U 000
				112–118	Color 16 R 000; G 255; B 255; W 150 A 000 U 000
				119–125	Color 17 R 000; G 100; B 255; W 255 A 000 U 000
				126–132	Color 18 R 000; G 000; B 255; W 100 A 000 U 000
				133–139	Color 19 R 000; G 000; B 255; W 050 A 000 U 000
				140–146	Color 20 R 000; G 000; B 255; W 000 A 000 U 000
				147–153	Color 21 R 075; G 000; B 255; W 000 A 000 U 000
				154–160	Color 22 R 160; G 000; B 255; W 000 A 000 U 000
				161–167	Color 23 R 255; G 000; B 255; W 000 A 000 U 000
				168–174	Color 24 R 255; G 000; B 175; W 000 A 000 U 000
				175–181	Color 25 R 255; G 000; B 100; W 000 A 000 U 000
				182–188	Color 26 R 255; G 000; B 100; W 050 A 000 U 000
				189–195	Color 27 R 255; G 000; B 025; W 050 A 000 U 000
				196–202	Color 28 R 255; G 000; B 025; W 025 A 000 U 000
				203–209	Color 29 R 255; G 000; B 025; W 000 A 000 U 000
				210–216	Color 30 R 000; G 000; B 000; W 255 A 000 U 000
				217–223	Color 31 R 075; G 075; B 000; W 255 A 000 U 000
				224–230	Color 32 R 000; G 000; B 100; W 200 A 000 U 255
				231–255	Color 33 R 255; G 255; B 255; W 255 A 255 U 255
		5	Built-in Programs	000–015	No function
				016–031	Color switch 1
				032–047	Color switch 2
				048–063	Color switch 3
				064–079	Color switch 4

6 CH	8 CH	12 CH	Function	Value	Setting
				080-095	Color switch 5
				096-111	Color switch 6
				112-127	Color switch 7
				128-143	Color switch 8
				144-159	Color fade 1
				160-175	Color fade 2
				176-191	Color fade 3
				192-207	Color fade 4
				208-223	Color fade 5
				224-239	Color fade 6
				240-255	Color fade 7
		6	Program Speed	000-255	Speed adjustment, from slow to fast
		7	Red	000-255	From low to high intensity (0-100 %)
		8	Green	000-255	From low to high intensity (0-100 %)
		9	Blue	000-255	From low to high intensity (0-100 %)
		10	White	000-255	From low to high intensity (0-100 %)
		11	Amber	000-255	From low to high intensity (0-100 %)
		12	UV	000-255	From low to high intensity (0-100 %)

Note:

- Make sure that Master Dimmer channel is open, to see the light output.
- Make sure that Color Presets or Built-in Programs or Red, Green, Blue, White, Amber and UV channels are open, if you want to use Linear or Pulse Strobe channels.
- Make sure that Color Presets and Built-in Programs channels are closed, if you want to use Red, Green, Blue, White, Amber or UV channels.
- Make sure that Built-in Programs channel is closed, if you want to use Color Presets channel.
- Make sure that Built-in Programs channel is open, if you want to use Program Speed channel.
- Make sure that Pulse Strobe channel is closed, if you want to use Linear Strobe channel.

6.8. RDM Information

This device supports RDM. Refer to **6.8.2. Supported RDM PIDs (Parameter IDs)** for more information.

6.8.1. RDM Details

- Responder: 29B4:0C1xxxxx
- Manufacturer's ID: Showtec (Highlite International B.V.)
- Manufacturer Label: Showtec
- Model Description: Cameleon Flood 15Q6 Tour
- Model ID: 193
- Device Label: Cameleon Flood 15Q6 Tour

6.8.2. Supported RDM PIDs (Parameter IDs)

Parameter ID	Value	Required	GET
DISC_UNIQUE_BRANCH	0x0001	*	
DISC_MUTE	0x0002	*	
DISC_UN_MUTE	0x0003	*	
SUPPORTED_PARAMETERS	0x0050	*	*
DEVICE_INFO	0x0060	*	*
DEVICE_MODEL_DESCRIPTION	0x0080		*
MANUFACTURER_LABEL	0x0081		*
DEVICE_LABEL	0x0082		*
FACTORY_DEFAULTS	0x0090		*
SOFTWARE_VERSION_LABEL	0x00C0	*	*
DMX_PERSONALITY	0x00E0		*
DMX_PERSONALITY_DESCRIPTION	0x00E1		*
DMX_START_ADDRESS	0x00F0	*	*
SENSOR_DEFINITION	0x0200		*
SENSOR_VALUE	0x0201		*
IDENTIFY_DEVICE	0x1000	*	*
RESET_DEVICE	0x1001		

6.8.3. Highlite RDM Details

All Highlite RDM responder IDs are divided into 3 parts, starting with a 4-digit Manufacturer's ID, followed by a 3-digit Model ID, and a 5-digit unique ID for each item.

As a result, RDM responder IDs will always start with the same 7 digits (exclusive to each type of device). The last 5 digits will be different for each device.

6.9. Remote Control

The device can be controlled with an IR remote control (44002).



DANGER
Do not ingest battery, chemical burn hazard

The remote control contains a coin cell battery. If the coin cell battery is swallowed, it can cause severe internal burns in just 2 hours and can lead to death.

The battery is already installed in the remote control. It is protected against discharge by a transparent plastic foil. Remove the plastic foil before using the remote control for the first time.

When replacing the battery, make sure that the polarity is correct. Incorrect polarity may damage the remote control.

You can control several devices at the same time with the remote control. Make sure that you point the remote control to the **infrared sensor (01)** of the device or group of devices that you want to control, as shown in Fig. 11. If you point the remote control to the **infrared sensor (01)** of the device outside of the range of the sensor, the device will not respond to the remote control (Fig. 12).

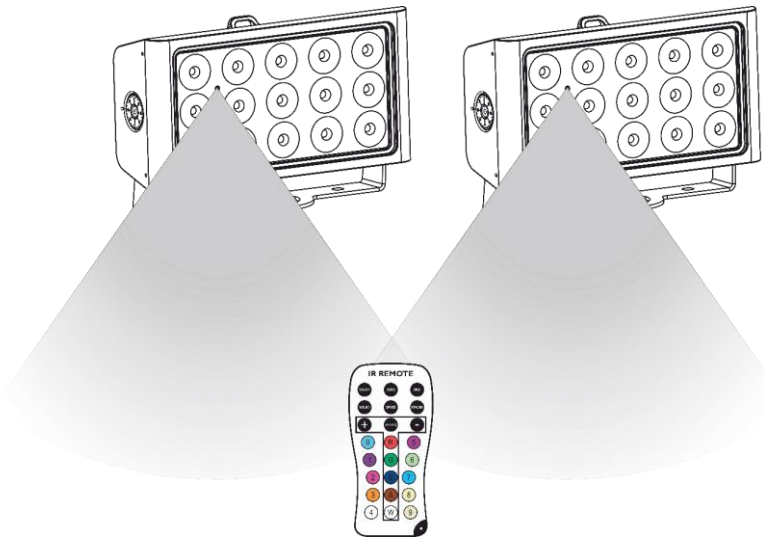

Fig. 11

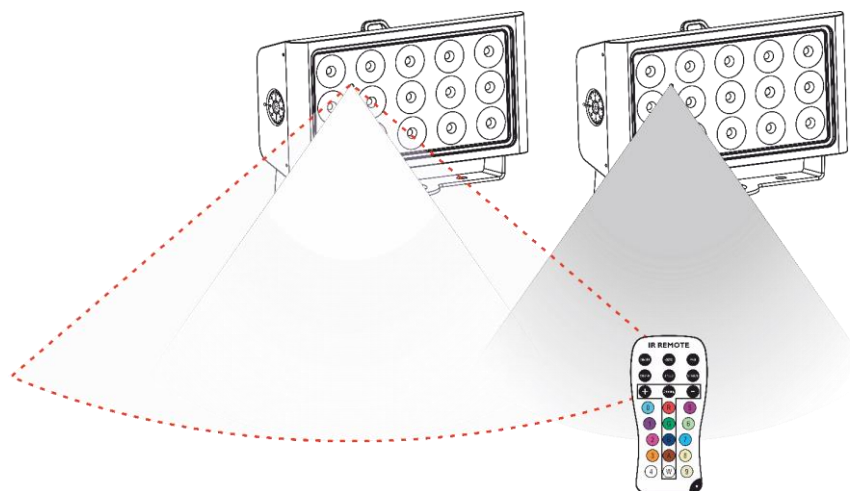

Fig. 12

To operate the device with the IR remote control, point the remote control to the **infrared sensor (01)**.

Note:

The remote control will work only if the device is already operating in Auto, Built-in Programs or Manual mode.

The remote control has the following functions:

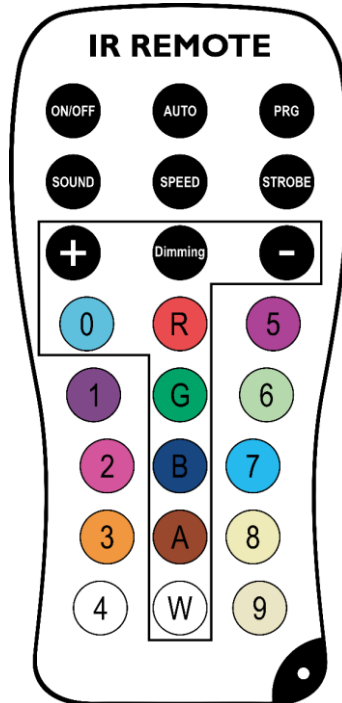

















Fig. 13

Note:

When you turn off the device, the next time you turn it on, it will continue to operate in the previously selected operation mode.



Button	Function	Description
ON/OFF	On/Off	Turns the LEDs on/off
AUTO	Auto	Activates Auto mode
PRG	Program	Activates Built-in Programs mode
SOUND	No function	
SPEED	Speed	Activates program speed adjustment
STROBE	Strobe	Activates strobe frequency adjustment
Dimming	Dimming	Activates Manual mode
+	Plus	Increase value
-	Minus	Decrease value

Button	Function	Description
	Red	Activates Red LEDs
	Green	Activates Green LEDs
	Blue	Activates Blue LEDs
	Amber	Activates Amber LEDs
	White	Activates White LEDs
	UV	Activates UV LEDs
	Color 22 (purple)	Activates color 22 (R 160; G 000; B 255; W 000)
	Color 23 (purple/pink)	Activates color 23 (R 255; G 000; B 255; W 000)
	Color 4 (orange)	Activates color 4 (R 255; G 050; B 000; W 000)
	Color 33 (cool white)	Activates color 33 (R 255; G 255; B 255; W 255)
	Color 25 (pink)	Activates color 25 (R 255; G 000; B 100; W 000)
	Color 8 (light green)	Activates color 8 (R 000; G 255; B 000; W 255)
	Color 18 (light blue)	Activates color 18 (R 000; G 000; B 255; W 100)
	Color 6 (light yellow)	Activates color 6 (R 255; G 255; B 000; W 000)
	Color 31 (warm white)	Activates color 31 (R 075; G 075; B 000; W 255)





6.9.1. Auto

Press the  button to activate Auto mode. The device will run its built-in programs in a sequence.



6.9.2. Built-in Programs

- 01) Press the  button to activate Built-in Programs mode.
- 02) Press the  and  buttons to select one of the 16 built-in programs.



6.9.2.1. Color Presets

- 01) Press the  -  buttons to select the color presets.
- 02) Press the  and  buttons to select one of the 33 color presets.

6.9.2.2. Strobe

- 01) Press the  button to set the strobe frequency.
- 02) Press the  and  buttons to increase/decrease the strobe frequency. The adjustment range is 0-99, from OFF to high strobe frequency.









6.9.2.3. Program Speed

- 01) Press the  button to set the program speed.
- 02) Press the  and  buttons to increase/decrease the program speed. The adjustment range is 1–100, from slow to fast.

Note:

If you select program 1 and start adjusting the program speed, the device will automatically switch to program 2. It is because the program speed function is available only in programs 2–16. The device searches for and activates the first following program that has the program speed function.

6.9.3. Manual

- 01) Press the  button to activate Manual mode.
- 02) Press the , , , , ,  button to choose one of the RGBWA-UV colors.
- 03) Press the  and  buttons to set the LED brightness of the selected color. The adjustment range is 0–255. You can combine Red, Green, Blue, White, Amber and UV to create an infinite range of colors.

7. Troubleshooting

This troubleshooting guide contains solutions to problems which can be carried out by an ordinary person. The device does not contain user-serviceable parts.

Unauthorized modifications to the device will render the warranty void. Such modifications may result in injuries and material damage.

Refer servicing to instructed or skilled persons. Contact your Highlite International dealer in case the solution is not described in the table.

Problem	Probable cause(s)	Solution
The device does not function at all	No power to the device	<ul style="list-style-type: none"> Check if power is switched on and cables are plugged in
	Internal fuse is blown	<ul style="list-style-type: none"> Disconnect the device and contact your Highlite International dealer
The device responds erratically	The factory settings of the device are changed	<ul style="list-style-type: none"> Reset the device's parameters to the default factory settings. See 6.6.6.6. Factory on page 28
The device does not respond to DMX control	The controller is not connected	<ul style="list-style-type: none"> Connect the controller
	The signal is reversed. The 3-pin DMX OUT of the controller does not match the DMX IN of the device	<ul style="list-style-type: none"> Install a phase-reversing cable between the controller and the device
	The controller is defective	<ul style="list-style-type: none"> Try using another controller
The device responds erratically to DMX control	Bad data link connection	<ul style="list-style-type: none"> Examine connections and cables. Correct poor connections. Repair or replace damaged cables
	The data link is not terminated with a 120 Ω termination plug	<ul style="list-style-type: none"> Insert a termination plug in the DMX OUT connector of the last device on the link
	Incorrect addressing	<ul style="list-style-type: none"> Check address settings and correct, if necessary
	In case of a setup with multiple devices, one of the devices is defective and disturbs data transmission on the link	<ul style="list-style-type: none"> To find out the defective device, bypass one device at a time until normal operation is restored
The device does not respond to the remote control	The remote control is outside of the range of the sensor of the infrared port	<ul style="list-style-type: none"> Walk closer to the device or change the angle at which you point the remote control to the device. See 6.9. Remote Control on page 32
	The battery of the remote control is depleted	<ul style="list-style-type: none"> Change the battery of the remote control
No light or LEDs cut out intermittently	LEDs are damaged	<ul style="list-style-type: none"> Disconnect the device and contact your Highlite International dealer
	The power supply settings do not match local AC voltage and frequency	<ul style="list-style-type: none"> Disconnect the device. Check the settings and correct, if necessary

8. Maintenance

8.1. Safety Instructions for Maintenance



DANGER
Electric shock caused by dangerous voltage inside

Disconnect power supply before servicing or cleaning.

8.2. Preventive Maintenance



Attention
Before each use, examine the device visually for any defects.

Make sure that:

- All screws used for installing the device or parts of the device are tightly fastened and are not corroded.
- The safety devices are not damaged.
- There are no deformations on housings, fixations and installation points.
- The lens is not cracked or damaged.
- The power cables are not damaged and do not show any material fatigue.

8.2.1. Basic Cleaning Instructions

The external lens of the device must be cleaned periodically in order to optimize the light output. The cleaning schedule depends on the conditions at the site where the device is installed. When smoke or fog machines are used at the site, the device will need more frequent cleaning. On the other hand, if the device is installed in well-ventilated area, it will need less frequent cleaning. To establish a cleaning schedule, examine the device at regular intervals during the first 100 hours of operation.

To clean the device, follow the steps below:

- 01) Disconnect the device from the electrical power supply.
- 02) Allow the device to cool down for at least 15 minutes.
- 03) Remove the dust collected on the external surface with dry compressed air and a soft brush.
- 04) Clean the lens with a damp cloth. Use a mild detergent solution.
- 05) Dry the lens carefully with a lint-free cloth.
- 06) Clean the DMX and other connections with a damp cloth.



Attention

- Do not immerse the device in liquid.
- Do not use alcohol or solvents.
- Make sure that the connections are fully dry before connecting the device to the power supply and to other devices.

8.2.2. Draining Condensation Water

The Cameleon Flood 15 Q6 Tour is IP65 rated. The device can resist water jets. If the device is exposed to extreme humid conditions during servicing, condensation may collect inside the device. This can happen also during transportation, if the device is exposed to extreme temperature variations.

If condensation water collects inside the device, follow the steps bellow to remove the condensation water:

01) Carefully remove the **protective valve (06)** with a wrench (16 mm).

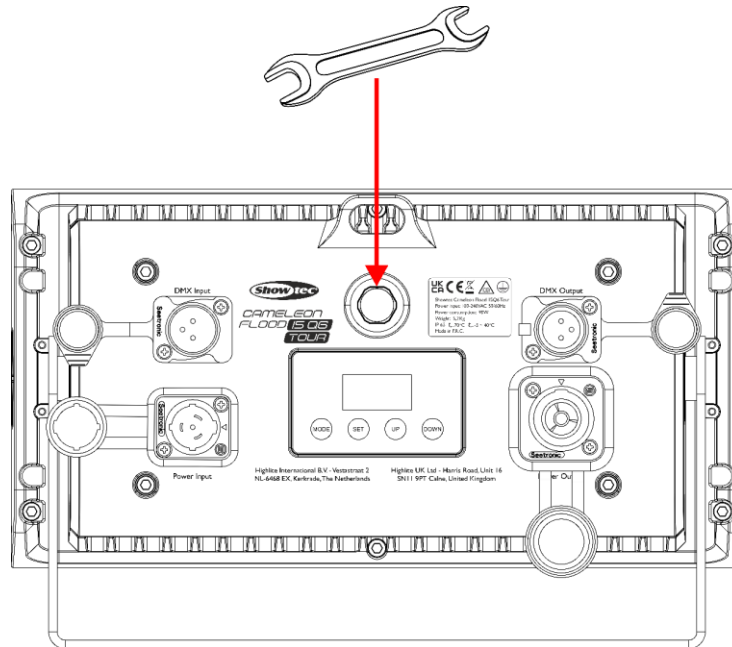

Fig. 14

02) Let the device operate at full output for 60 minutes.

03) Let the device cool down for 30 minutes.

04) Install the **protective valve (06)** back in place. Make sure that you do not overtighten it.

8.3. Corrective Maintenance

The device does not contain user-serviceable parts. Do not open the device and do not modify the device.

Refer repairs and servicing to instructed or skilled persons. Contact your Highlite International dealer for more information.

9. Deinstallation, Transportation and Storage

9.1. Instructions for Deinstallation



WARNING

Incorrect deinstallation can cause serious injuries and damage of property.

- Let the device cool down before dismounting.
- Disconnect power supply before deinstallation.
- Always observe the national and site-specific regulations during deinstallation and derigging of the device.
- Wear personal protective equipment in compliance with the national and site-specific regulations.

9.2. Instructions for Transportation

- Use the original packaging to transport the device, if possible.
- Always observe the handling instructions printed on the outer carton box, for example: "Handle with care", "This side up", "Fragile".

9.3. Storage

- Clean the device before storing. Follow the cleaning instructions in chapter **8.2.1. Basic Cleaning Instructions** on page 37.
- Store the device in the original packaging, if possible.

10. Disposal

Correct disposal of this product

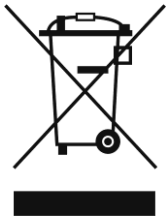

Waste Electrical and Electronic Equipment

This symbol on the product, its packaging or documents indicates that the product shall not be treated as household waste. Dispose of this product by handing it to the respective collection point for recycling of electrical and electronic equipment. This is to avoid environmental damage or personal injury due to uncontrolled waste disposal. For more detailed information about recycling of this product contact the local authorities or the authorized dealer.

11. Approval



Check the respective product page on the website of Highlite International (www.highlite.com) for an available declaration of conformity.



©2023 Showtec