

ENGLISH

Infinity TF-300 Fresnel

V1

**Ordercode: 200202
Firmware Version 1.04**

Table of contents



| | |
|--|----|
| Warning | 3 |
| Safety Instructions | 3 |
| Operating Determinations | 5 |
| Rigging | 5 |
| Connection with the mains..... | 6 |
| Return Procedure..... | 7 |
| Claims..... | 7 |
| Description of the device | 8 |
| Side | 9 |
| Backside | 10 |
| Installation | 10 |
| Set Up and Operation | 10 |
| Installing Filterframe | 11 |
| Installing barndoor | 12 |
| Control Modes..... | 13 |
| One Fresnel (Manual control) | 13 |
| Multiple Fresnels (DMX Control) | 13 |
| Fixture Linking..... | 14 |
| Data Cabling..... | 14 |
| Control Panel..... | 15 |
| Control Mode | 15 |
| DMX Addressing..... | 15 |
| Menu Overview..... | 16 |
| Activate Focus Mode | 17 |
| Main Menu Options | 17 |
| 1. DMX Configuration..... | 18 |
| 2. DMX Address | 18 |
| 3. Manual..... | 18 |
| 3.1 Dimmer | 18 |
| 3.2 Zoom | 18 |
| 4. Dimmer Curves..... | 19 |
| 5. Dimmer Speed | 19 |
| 6. DMX Lost Mode | 20 |
| 7. Fan Mode | 20 |
| 8. PWM Frequency..... | 20 |
| 9. Display..... | 20 |
| 10. Zoom Motor | 21 |
| 10.1 Reset Motor..... | 21 |
| 10.2 Encoder | 21 |
| 10.3 Enable Motor..... | 21 |
| 11. Info..... | 22 |
| 12. Reset Factory Settings..... | 22 |
| DMX Channels | 23 |
| 1 Channel (Dimmer)..... | 23 |
| 3 Channels (Basic) | 23 |
| 5 Channels (Pro)..... | 23 |
| Maintenance | 24 |
| Cleaning the Field Lens | 24 |
| Troubleshooting | 24 |
| No Light | 24 |
| No Response to DMX..... | 25 |

Product Specifications26

Dimensions.....27

Notes.....28

Warning

 **For your own safety, please read this user manual carefully before your initial start-up!** 

Unpacking Instructions

Immediately upon receiving this product, carefully unpack the carton and check the contents to ensure that all parts are present, and have been received in good condition. Notify the dealer immediately and retain packing material for inspection if any parts appear damaged from shipping or the carton itself shows signs of mishandling. Save the carton and all packing materials. In the event that a fixture must be returned to the factory, it is important that the fixture be returned in the original factory box and packing.

Your shipment includes:

- Infinity TF-300 Fresnel
- Neutrik PowerCON to Schuko power cable (1,4 m)
- Safety cable
- User manual

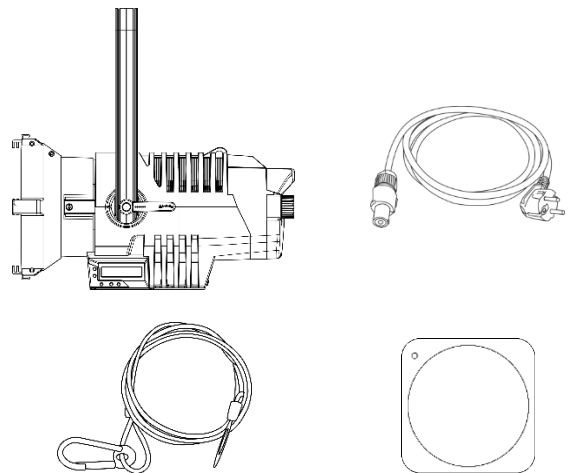

LED Expected Lifespan



LEDs gradually decline in brightness over time. HEAT is the dominant factor that leads to the acceleration of this decline. Packaged in clusters, LEDs exhibit higher operating temperatures than in ideal or singular optimum conditions. For this reason when all color LEDs are used at their fullest intensity, life of the LEDs is significantly reduced. If improving your lifespan expectancy is of a higher priority, place care in providing for lower operational temperatures. This may include climatic-environmental and the reduction of overall projection intensity.

 **CAUTION!** 
Keep this device away from rain and moisture!
Unplug mains lead before opening the housing!

Safety Instructions

Every person involved with the installation, operation and maintenance of this device has to:

- be qualified
- follow the instructions of this manual

 **CAUTION! Be careful with your operations.** 
With a dangerous voltage you can suffer a dangerous electric shock when touching the wires!

Before your initial start-up, please make sure that there is no damage caused by transportation. Should there be any, consult your dealer and do not use the device.

To maintain perfect condition and to ensure a safe operation, it is absolutely necessary for the user to follow the safety instructions and warning notes written in this manual.

Please consider that damages caused by manual modifications to the device are not subject to warranty.

This device contains no user-serviceable parts. Refer servicing to qualified technicians only.

IMPORTANT:

The manufacturer will not accept liability for any resulting damages caused by the non-observance of this manual or any unauthorized modification to the device.

- Never let the power cord come into contact with other cables! Handle the power cord and all connections with the mains with particular caution!
- Never modify, bend, mechanically strain, put pressure on, pull or heat up the power cord.
- Never strain the cable insert or the female part in the device. There must always be sufficient cable going to the device. Otherwise, the cable will be damaged, which can cause serious damage.
- Never remove warning or informative labels from the unit.
- Never use anything to cover the ground contact.
- Never lift the device holding it by the projector-head, as the mechanics may be damaged. Always hold the device by the transport handles.
- Never place any material over the lens.
- Never look directly into the light source.
- Never leave any cables lying around.
- Never use the device during thunderstorms, unplug the device immediately.
- Never leave various parts of the packaging (plastic bags, polystyrene foam, nails, etc.) within children's reach, as they are potential sources of danger.
- Do not insert objects into air vents.
- Do not open the device and do not modify the device.
- Do not connect this device to a dimmer pack.
- Do not switch the device on and off in short intervals, as this will reduce the device's life.
- Do not touch the device's housing bare-handed during its operation (housing becomes hot). Allow the device to cool for at least 5 minutes before handling.
- Do not shake the device. Avoid brute force when installing or operating the device.
- Only use the device indoors, avoid contact with water or other liquids.
- Only operate the device after having checked if the housing is firmly closed and all screws are tightly fastened.
- Only operate the device after having familiarized with its functions.
- Avoid flames and do not put close to flammable liquids or gases.
- Always keep the case closed while operating.
- Always allow a free air space of at least 50 cm around the unit for ventilation.
- Always disconnect power from the mains, when device is not used or before cleaning! Only handle the power cord holding it by the plug. Never pull out the plug by tugging the power cord.
- Make sure that the device is not exposed to extreme heat, moisture or dust.
- Make sure that the available voltage is not higher than stated on the rear panel.
- Make sure that the power cord is never crimped or damaged. Check the device and the power cord from time to time.
- Make sure that the core diameter of extension cords and power cords is sufficient for the required power consumption of the device.
- If the lens is obviously damaged, it has to be replaced to prevent its functions from being impaired, due to cracks or deep scratches.
- If the external cable is damaged, it has to be replaced by a qualified technician.
- If device was dropped or struck, disconnect mains power supply immediately. Have a qualified engineer inspect for safety before operating.
- If the device has been exposed to drastic temperature fluctuation (e.g. after transportation), do not switch it on immediately. The arising condensation water might damage your device. Leave the device switched off until it has reached room temperature.

- If your device fails to work properly, discontinue the use immediately. Pack the unit securely (preferably in the original packing material), and return it to your Infinity dealer for service.
- For adult use only. The device must be installed beyond the reach of children. Never leave the unit running unattended.
- Never attempt to bypass the thermostatic switch or fuses.
- For replacement use fuses of same type and rating only.
- The user is responsible for correct positioning and operating of the device. The manufacturer will not accept liability for damages caused by the misuse or incorrect installation of this device.
- This device falls under protection class I. Therefore it is essential to connect the yellow/green conductor to earth.
- Repairs, servicing and electric connection must be carried out by a qualified technician.
- WARRANTY: Till one year after date of purchase.

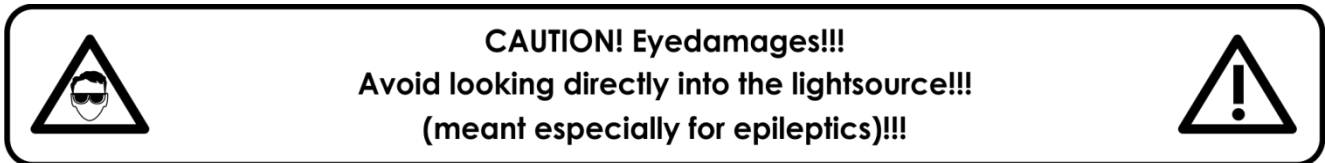

Operating Determinations

- This device is not designed for permanent operation. Consistent operation breaks will ensure that the device will serve you for a long time without defects.
- The minimum distance between light output and the illuminated surface must be bigger than 1 meter.
- In order to eliminate wear and improve the device's lifespan, during periods of non-use, completely disconnect from power source via breaker or by unplugging.
- The maximum ambient temperature $t_a = 40^{\circ}\text{C}$ must never be exceeded.
- The relative humidity must not exceed 50 % with an ambient temperature of 40°C .
- If this device is operated in any other way than the one described in this manual, the product may suffer damages and the warranty becomes void.
- Any other operation may lead to dangers like short-circuit, burns, electric shock, crash, etc.

You endanger your own safety and the safety of others!

Rigging

Please follow the European and national guidelines concerning rigging, trussing and all other safety issues.

Do not attempt the installation yourself !

Always let the installation be carried out by an authorized dealer !

Procedure:

- If the device is lowered from the ceiling or high joists, professional trussing systems have to be used.
- Use a clamp to mount the device, with the mounting bracket, to the trussing system.
- The device must never be fixed swinging freely in the room.
- The installation must always be secured with a safety attachment, e.g. an appropriate safety net or safety cable.
- When rigging, derigging or servicing the device, always make sure, that the area below the installation place is blocked and staying in the area is forbidden.

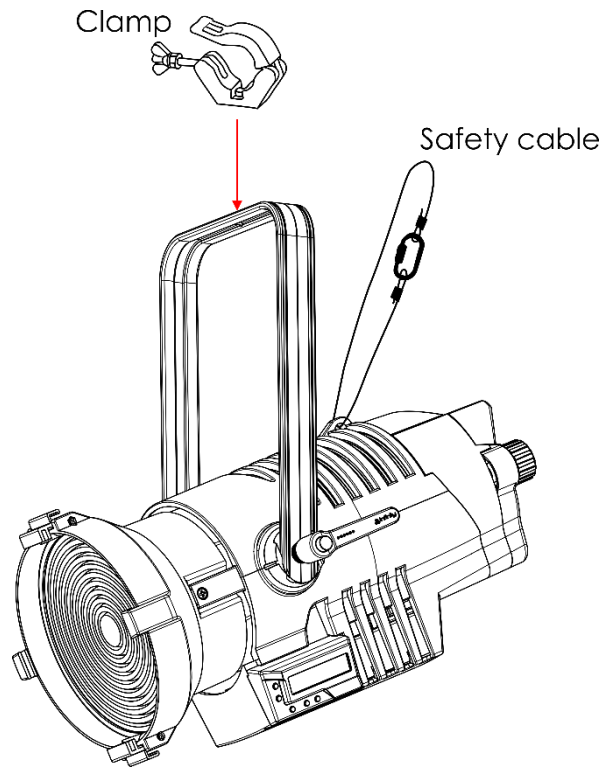

The TF-300 Fresnel can be placed on a flat stage floor or mounted to any kind of truss with a clamp.

Improper installation can cause serious injuries and/or damage of property !

Connection with the mains

Connect the device to the mains with the power-plug.

Always pay attention, that the right color cable is connected to the right place.

| International | EU Cable | UK Cable | US Cable | Pin |
|---------------|--------------|----------|---------------|-------|
| L | BROWN | RED | YELLOW/COPPER | FASE |
| N | BLUE | BLACK | SILVER | NULL |
| ⊕ | YELLOW/GREEN | GREEN | GREEN | EARTH |

Make sure that the device is always connected properly to the earth!

Improper installation can cause serious injuries and/or damage of property !

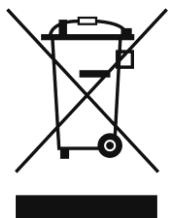

**Return Procedure**

Returned merchandise must be sent prepaid and in the original packing, call tags will not be issued. Package must be clearly labeled with a Return Authorization Number (RMA number). Products returned without an RMA number will be refused. Highlite will not accept the returned goods or any responsibility. Call Highlite 0031-455667723 or mail aftersales@highlite.com and request an RMA prior to shipping the fixture. Be prepared to provide the model number, serial number and a brief description of the cause of the return. Be sure to properly pack fixture as any shipping damage resulting from inadequate packaging is the customer's responsibility. Highlite reserves the right to use its own discretion to repair or replace product(s). As a suggestion, proper UPS packing or double-boxing is always a safe method to use.

Note: If you are given an RMA number, please include the following information on a piece of paper inside the box:

- 01) Your name.
- 02) Your address.
- 03) Your phone number.
- 04) A brief description of the symptoms.

Claims

The client has the obligation to check the delivered goods immediately upon delivery for any shortcomings and/or visible defects, or perform this check after our announcement that the goods are at their disposal. Damage incurred in shipping is the responsibility of the shipper; therefore the damage must be reported to the carrier upon receipt of merchandise.

It is the customer's responsibility to notify and submit claims with the shipper in the event that the fixture is damaged due to shipping. Transportation damage has to be reported to us within one day after receipt of the delivery.

Any return shipment has to be made post-paid at all times. Return shipments must be accompanied with a letter defining the reason for return shipment. Non-prepaid return shipments will be refused, unless agreed otherwise in writing.

Complaints against us must be made known in writing or by fax within 10 working days after receipt of the invoice. After this period, complaints will not be handled anymore.

Complaints will only be considered if the client has so far complied with all parts of the agreement, regardless of the agreement of which the obligation is resulting.

Description of the device

Features

The Infinity TF-300 Fresnel a state of the art high-resolution theatrical luminaire with high output.

- Delivers the performance of 1kW Tungsten Halogen unit with a consumption of 300W
- Manual and motorized zoom control
- Consistent colour temperature regardless of output intensity
- RDM allowing for remote setting and recall of information
- Intuitive on-board menus
- Input voltage: 100-240V AC, 50/60Hz
- Power consumption: 300W
- Power factor: 0,97
- Light source: 300W Lumiled White LED
- Light output: 5000lm
- Color Temperature: 3200K
- CRI: Consistently >96% (High CRI Mode)
- Zoom range: 15°-50°
- Dimmer: 0-100%
- Strobe: 0-20Hz
- Dimmer curves: Linear, Gamma 2.0, Gamma 2.2, S-curve
- DMX channels: 1, 3 or 5 channels
- Ambient temperature: 0°-40° (operating)
- Startup temperature: -10°-45°
- IP rating: P20, indoor use only
- Fan mode: Silent, Auto, Full
- LC-display for easy setup
- DMX-control: via standard DMX/RDM controller
- Control: DMX-512, Manual control, RDM
- Housing: Black aluminum, sheet metal, molded engineering grade plastics
- Connections: Neutrik PowerCON IN/OUT , Neutrik 3-pin XLR data IN/OUT, Neutrik 5-pin XLR data IN/OUT
- Dimensions: 509 x 322 x 450 mm (LxWxH) (incl. bracket)
- Weight: 8,3 kg

Note: Knowledge of DMX is required to fully utilize this unit.

Optional accessories

[200250](#) – Filterframe for Infinity Fresnel

[200251](#) – Barndoor for Infinity Fresnel

Side

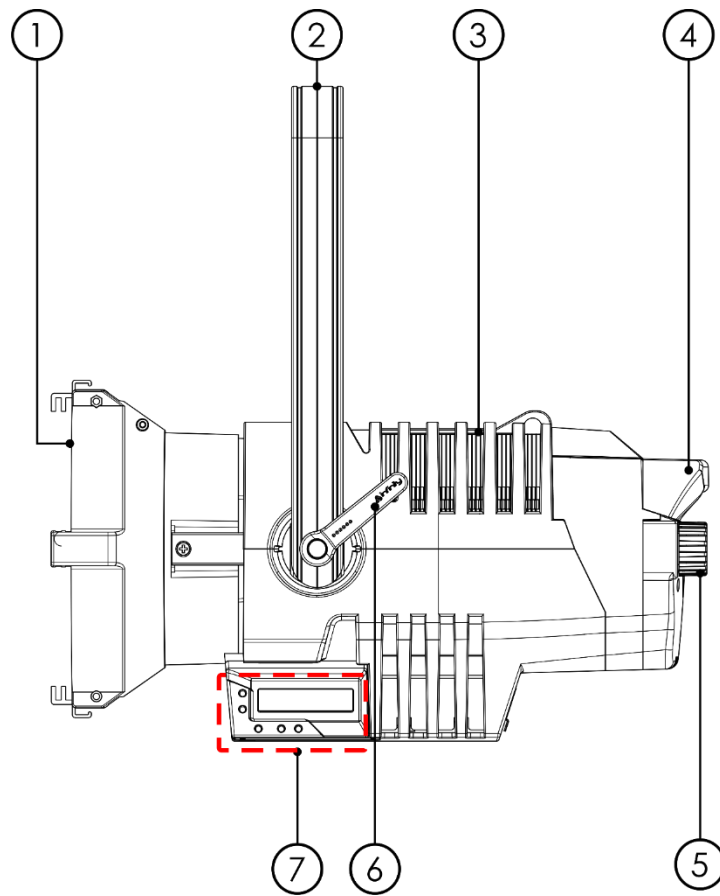

Fig. 01

- 01) 300W Lumiled White LED
- 02) Mounting bracket
- 03) Safety eye
- 04) Rear handle
- 05) Manual Focus
- 06) Adjustment handle
- 07) Control buttons + LC-display

Backside

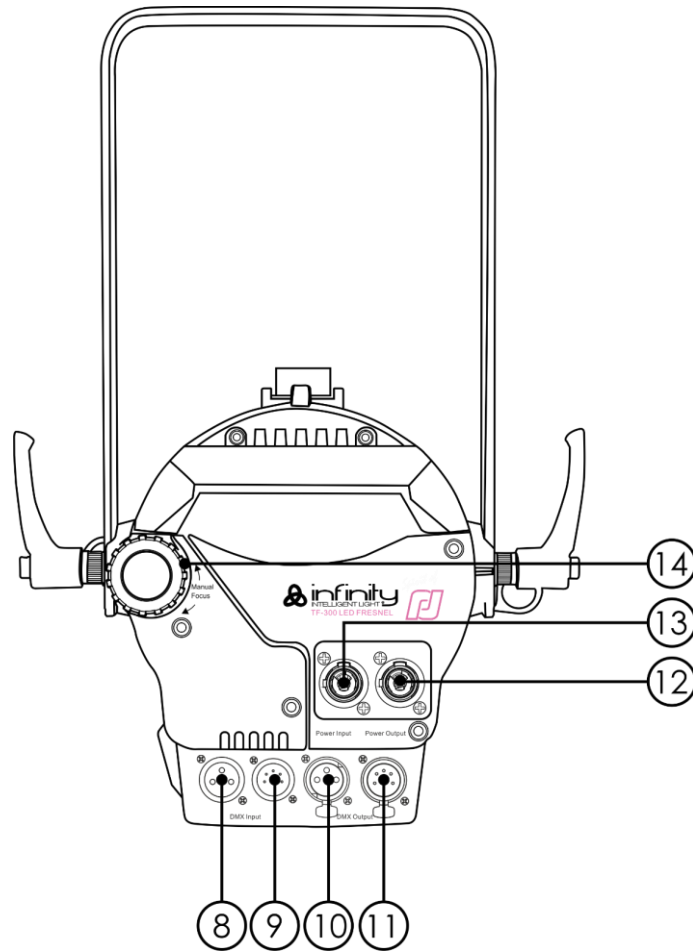

Fig. 03

- 08) Neutrik 3-pin DMX signal connector IN
- 09) Neutrik 5-pin DMX signal connector IN
- 10) Neutrik 3-pin DMX signal connector OUT
- 11) Neutrik 5-pin DMX signal connector OUT
- 12) Neutrik PowerCON IN (Blue)
- 13) Neutrik PowerCON OUT (Gray)
- 14) Manual Focus

Installation

Remove all packing materials from the Infinity TF-300 Fresnel. Check that all foam and plastic padding is removed. Connect all cables.

Do not supply power before the whole system is set up and connected properly.

Always disconnect from electric mains power supply before cleaning or servicing.

Damages caused by non-observance are not subject to warranty.

Set Up and Operation

Follow the directions below, as they pertain to your preferred operation mode.

Before plugging the unit in, always make sure that the power supply matches the product specification voltage. Do not attempt to operate a 120V specification product on 230V power, or vice versa.

Installing Filterframe

- 01) Push the upper spring lever sideways.
- 02) Pull the upper spring lever in the direction of the arrow.
- 03) Make sure the upper lever is pulled backwards and insert the filterframe (ordercode: 200250) into the lower spring lever.
- 04) Release the upper spring lever.
- 05) Make sure the filterframe is firmly positioned between the upper spring lever and the lower spring lever.

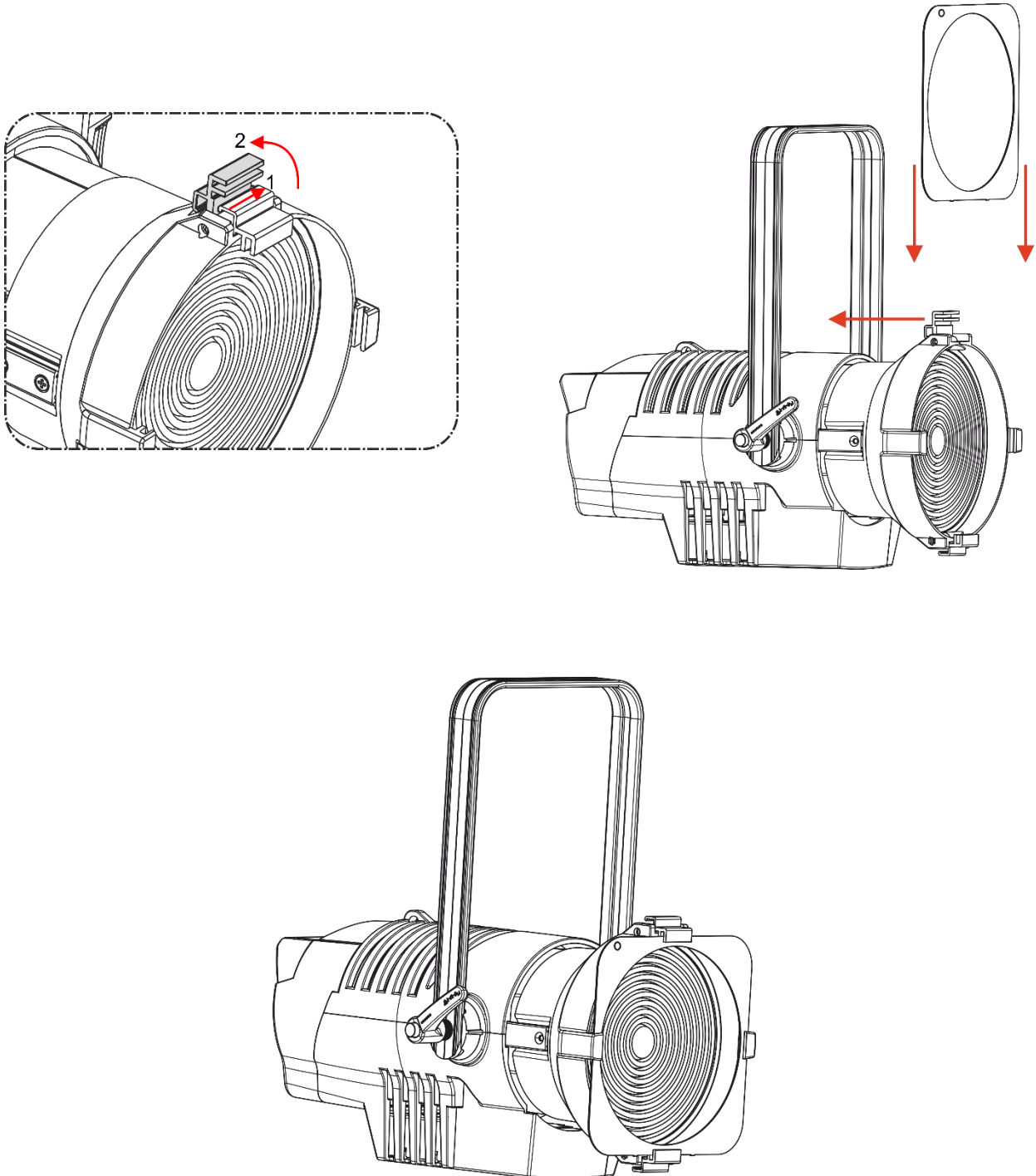

Fig. 04

Installing barndoor

- 01) Push the upper spring lever sideways.
- 02) Pull the upper spring lever in the direction of the arrow.
- 03) Make sure the upper lever is pulled backwards and insert the barndoor (ordercode: 200251) in the lower spring lever.
- 04) Replace the upper spring lever in the start position.
- 05) Make sure the barndoor is firmly positioned between the upper spring lever and the lower spring lever.

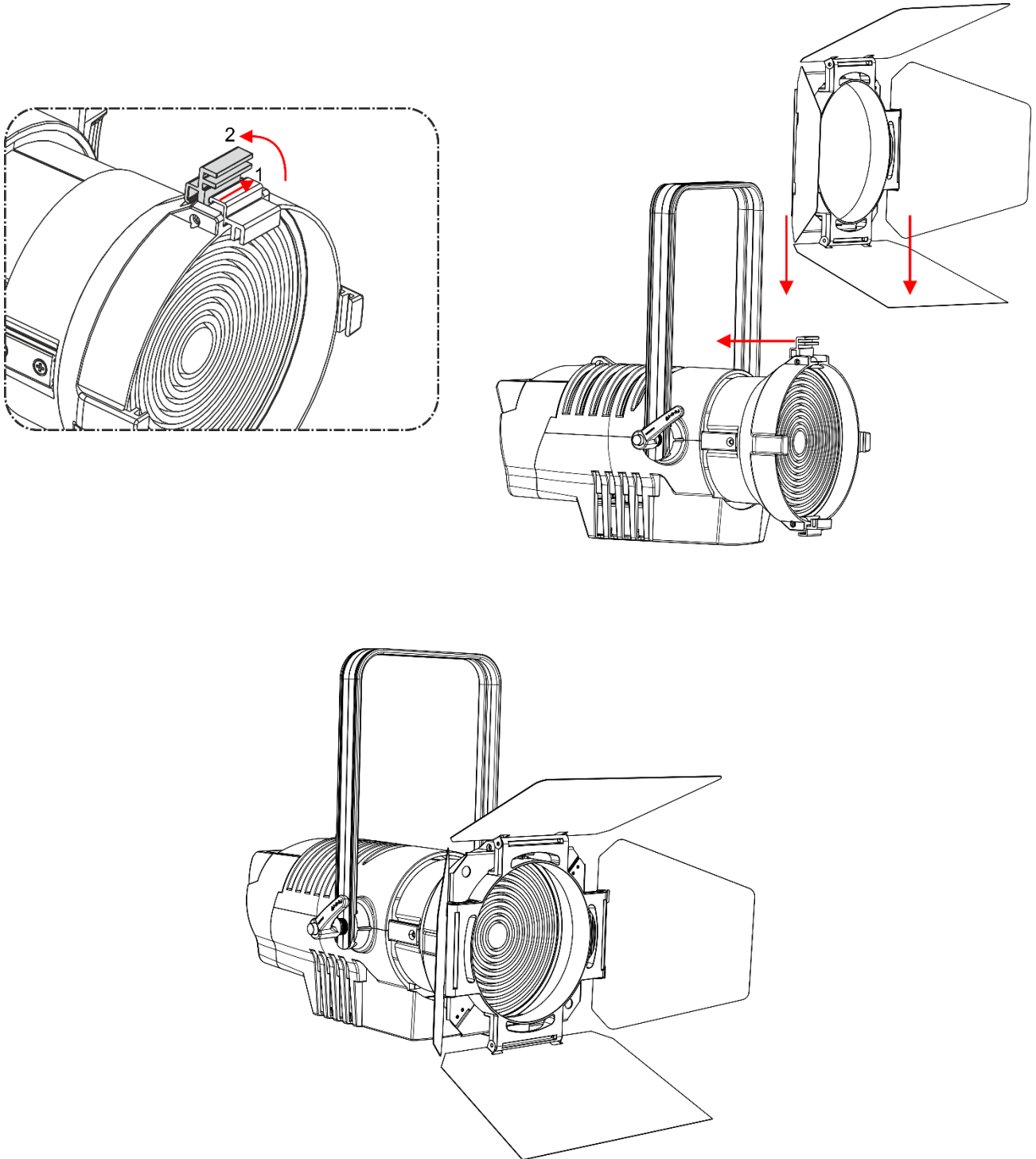

Fig. 05

Control Modes

- There are 2 modes:
- Manual control
 - DMX512 (1CH, 3CH, 5CH)

One Fresnel (Manual control)

- 01) Fasten the effect light onto firm trussing. Leave at least 0,5 meter on all sides for air circulation.
- 02) Always use a safety cable (ordercode 70140 / 70141).
- 03) Plug the end of the electric mains power cord into a proper electric power supply socket.
- 04) When the Fresnel is not connected with a DMX cable, it functions as a stand-alone device.
- 05) Please see page 19 for more information about the Manual control mode.

Multiple Fresnels (DMX Control)

- 01) Fasten the effect light onto firm trussing. Leave at least 0,5 meter on all sides for air circulation.
- 02) Always use a safety cable (ordercode 70140 / 70141).
- 03) Plug the end of the electric mains power cord into a proper electric power supply socket.
- 04) Use a 3-pin XLR cable to connect the Fresnels and other devices.



- 05) Link the units as shown in fig. 06. Connect a DMX signal cable from the first unit's DMX "out" socket to the second unit's "in" socket. Repeat this process to link the second, third, and fourth units.
- 06) Supply electric power: Plug electric mains power cords into each unit's PowerCON socket, then plug the other end of the mains power cord into proper electric power supply sockets, starting with the first unit. Do not supply power before the whole system is set up and connected properly.

Multiple Fresnels DMX Set Up

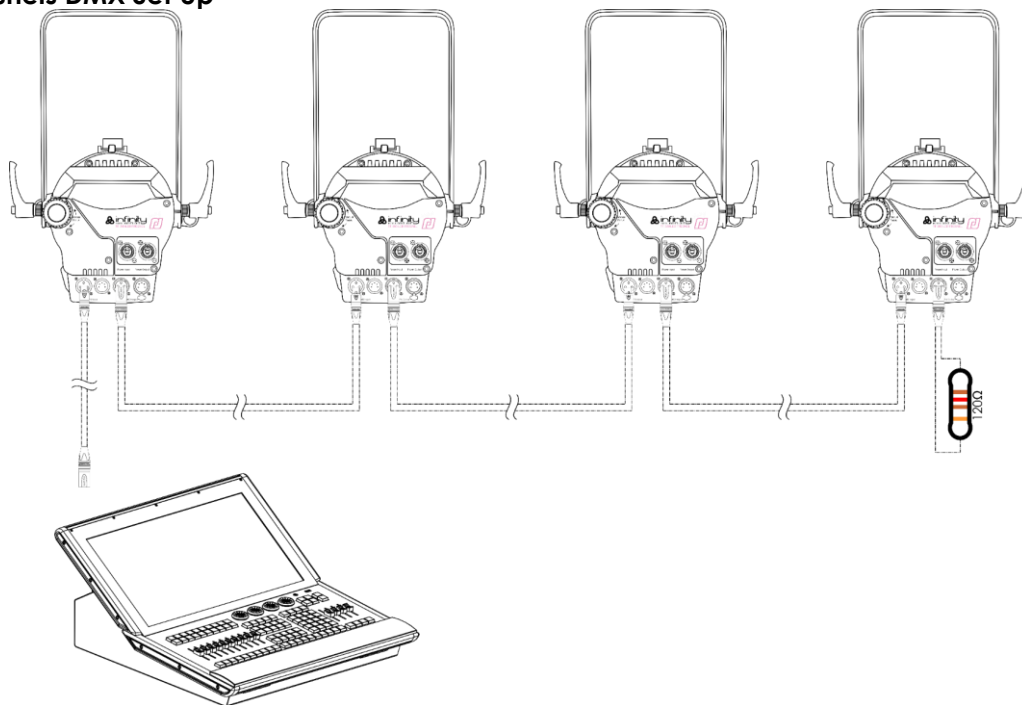



Fig. 06

Note: Link all cables before connecting electric power

Fixture Linking

You will need a serial data link to run light shows of one or more fixtures using a DMX-512 controller or to run synchronized shows on two or more fixtures set to a master/slave operating mode. The combined number of channels required by all the fixtures on a serial data link determines the number of fixtures the data link can support.

Important: Fixtures on a serial data link must be daisy chained in one single line. To comply with the EIA-485 standard no more than 30 devices should be connected on one data link. Connecting more than 30 fixtures on one serial data link without the use of a DMX optically isolated splitter may result in deterioration of the digital DMX signal.

 Maximum recommended DMX data link distance: 100 meters
Maximum recommended number of fixtures on a DMX data link: 30 fixtures
Maximum recommended number of fixtures on a power link @120V: 3 fixtures
Maximum recommended number of fixtures on a power link @230V: 6 fixtures

Data Cabling

To link fixtures together you must obtain data cables. You can purchase DAP Audio certified DMX cables directly from a dealer/distributor or construct your own cable. If you choose to create your own cable please use data-grade cables that can carry a high quality signal and are less prone to electromagnetic interference.

DMX Data Cables

- DAP 110 Ohm cable with digital signal transmission. **Ordercode** FL0975 (0,75 m), FL09150 (1,5 m), FL093 (3 m), FL096 (6 m), FL0910 (10 m), FL0915 (15 m), FL0920 (20 m).
- DAP data cable FL08 DMX/AES-EBU, XLR/M 5-pin > XLR/F 5-pin. **Ordercode** FL08150 (1,5 m), FL083 (3 m), FL086 (6 m), FL0810 (10 m), FL0820 (20 m).
- DAP DMX adapter: 5-pin > 3-pin. **Ordercode** FLA29.
- DAP DMX adapter: 3-pin > 5-pin. **Ordercode** FLA30.
- DAP DMX Terminator 3-pin. **Ordercode** FLA42.
- DAP DMX Terminator 5-pin. **Ordercode** FLA43.

The Infinity TF-300 Fresnel can be operated with a controller in **control mode** or without the controller in **stand-alone mode**.

Control Panel

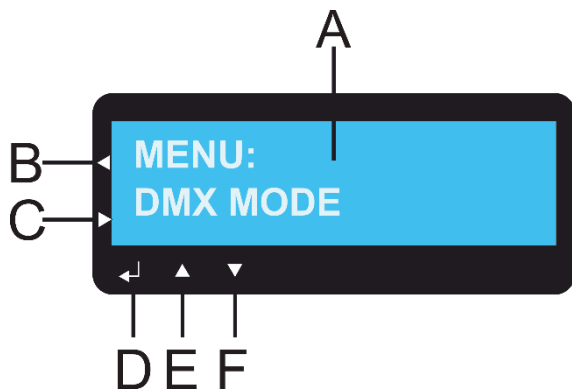

- A) LC-display
- B) Home button
- C) Return button
- D) Enter button
- E) Up button
- F) Down button

Fig. 07

Control Mode

The fixtures are individually addressed on a data-link and connected to the controller.

The fixtures respond to the DMX signal from the controller. (When you select the DMX address and save it, the controller will display the saved DMX address the next time.)

DMX Addressing

The control panel on the front side of the base allows you to assign the DMX fixture address, which is the first channel from which the Fresnel will respond to the controller.

Please note when you use the controller, the unit has **5** channels.

When using multiple Fresnels, make sure you set the DMX addresses right.

Therefore, the DMX address of the first Fresnel should be **1(005)**; the DMX address of the second Fresnel should be **1+5=6 (006)**; the DMX address of the third Fresnel should be **6+5=11 (011)**, etc.

Please, be sure that you do not have any overlapping channels in order to control each Fresnel correctly. If two or more Fresnels are addressed similarly, they will work similarly.

Controlling:

After having addressed all Fresnel fixtures, you may now start operating these via your lighting controller.

Note: After switching on, the Fresnel will automatically detect whether DMX 512 data is received or not. If not the problem may be:

- The XLR cable from the controller is not connected with the input of the Fresnel.
- The controller is switched off or defective, the cable or connector is defective, or the signal wires are swapped in the input connector.

Note: It's necessary to insert a XLR termination plug (with 120 Ohm) in the last fixture in order to ensure proper transmission on the DMX data link.

Menu Overview

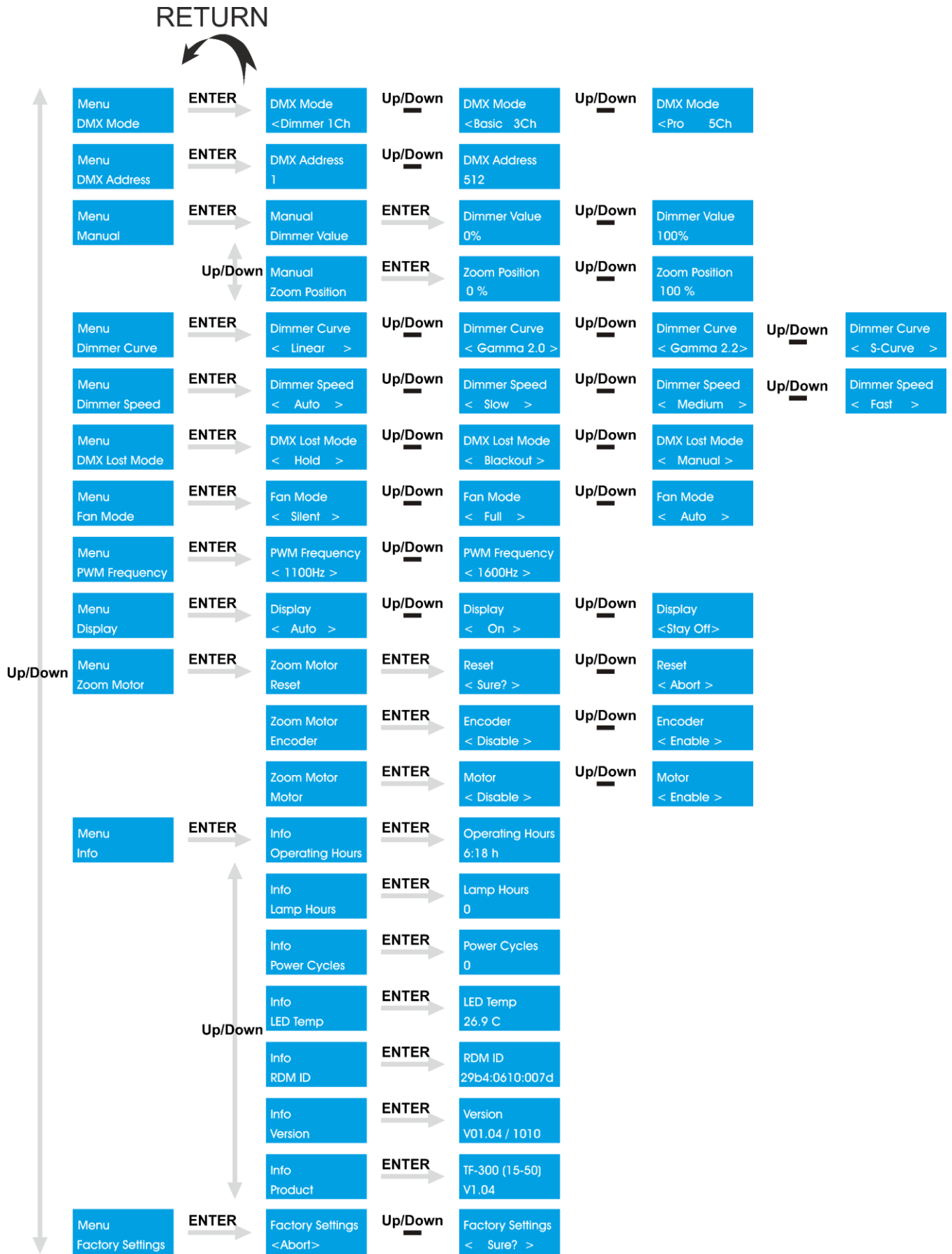

The Infinity TF-300 will show the Info screen at start-up !

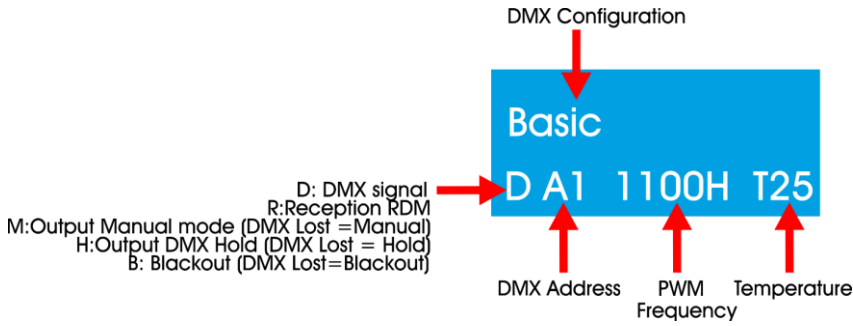

Press the **Home button** (B) to switch between the Info screen and the current menu mode.
Press the **Return button** (C) to go back to the main menu.

Activate Focus Mode



Press and hold down the **Home button** (B) for 2 sec. The output will be open white 3200K (Focus mode). The device automatically returns to normal mode after 3 min. or when the **Home button** is pressed again.

Main Menu Options

| | |
|--------------------------|------------------------|
| Menu DMX Mode | DMX Configuration |
| Menu DMX Address | DMX Address |
| Menu Manual | Manual mode |
| Menu Dimmer Curve | Dimmer curves |
| Menu Dimmer Speed | Dimmer speed |
| Menu DMX Lost Mode | DMX Lost mode |
| Menu Fan Mode | Fan mode |
| Menu PWM Frequency | PWM Frequency |
| Menu Display | Display |
| Menu Zoom Motor | Zoom motor |
| Menu Info | Info |
| Menu Factory Settings | Reset factory settings |

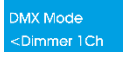

1. DMX Configuration

In this menu you can choose a DMX configuration.

- 01) While in the main menu, press the **UP/DOWN** buttons until the display shows .
- 02) Press the **ENTER** button to open the menu.
- 03) Press the **UP/DOWN** buttons to choose one of the 3 channel modes ,  or .
- 04) Press the **ENTER** button to confirm.

2. DMX Address

In this menu you can set the DMX address.

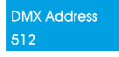
- 01) While in the main menu, press the **UP/DOWN** buttons until the display shows .
- 02) Press the **ENTER** button to open the menu.
- 03) Press the **UP/DOWN** buttons to set the device's DMX starting address. The adjustment range is between   .
- 04) Press the **ENTER** button to confirm.

3. Manual

In this menu you can set the manual settings of the Fresnel.

- 01) While in the main menu, press the **UP/DOWN** buttons until the display shows .
- 02) Press the **ENTER** button to open the submenu.
- 03) Press the **UP/DOWN** buttons to choose between the 2 options:

 Dimmer

 Zoom

- 04) Press the **ENTER** button to confirm.

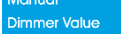

3.1 Dimmer

- 01) Press the **UP/DOWN** buttons until the display shows .
- 02) Press the **ENTER** button to open the submenu.
- 03) Press the **UP/DOWN** buttons to set the dimmer value. The adjustment range is between

  .

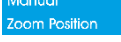
3.2 Zoom

- 01) Press the **UP/DOWN** buttons until the display shows .
- 02) Press the **ENTER** button to open the submenu.
- 03) Press the **UP/DOWN** buttons to set the zoom. The adjustment range is between

  .

4. Dimmer Curves

In this menu you can choose a dimmer curve.

- 01) While in the main menu, press the **UP/DOWN** buttons until the display shows Menu
Dimmer Curve.
- 02) Press the **ENTER** button to open the menu.
- 03) Press the **UP/DOWN** buttons to choose from the 4 available options:

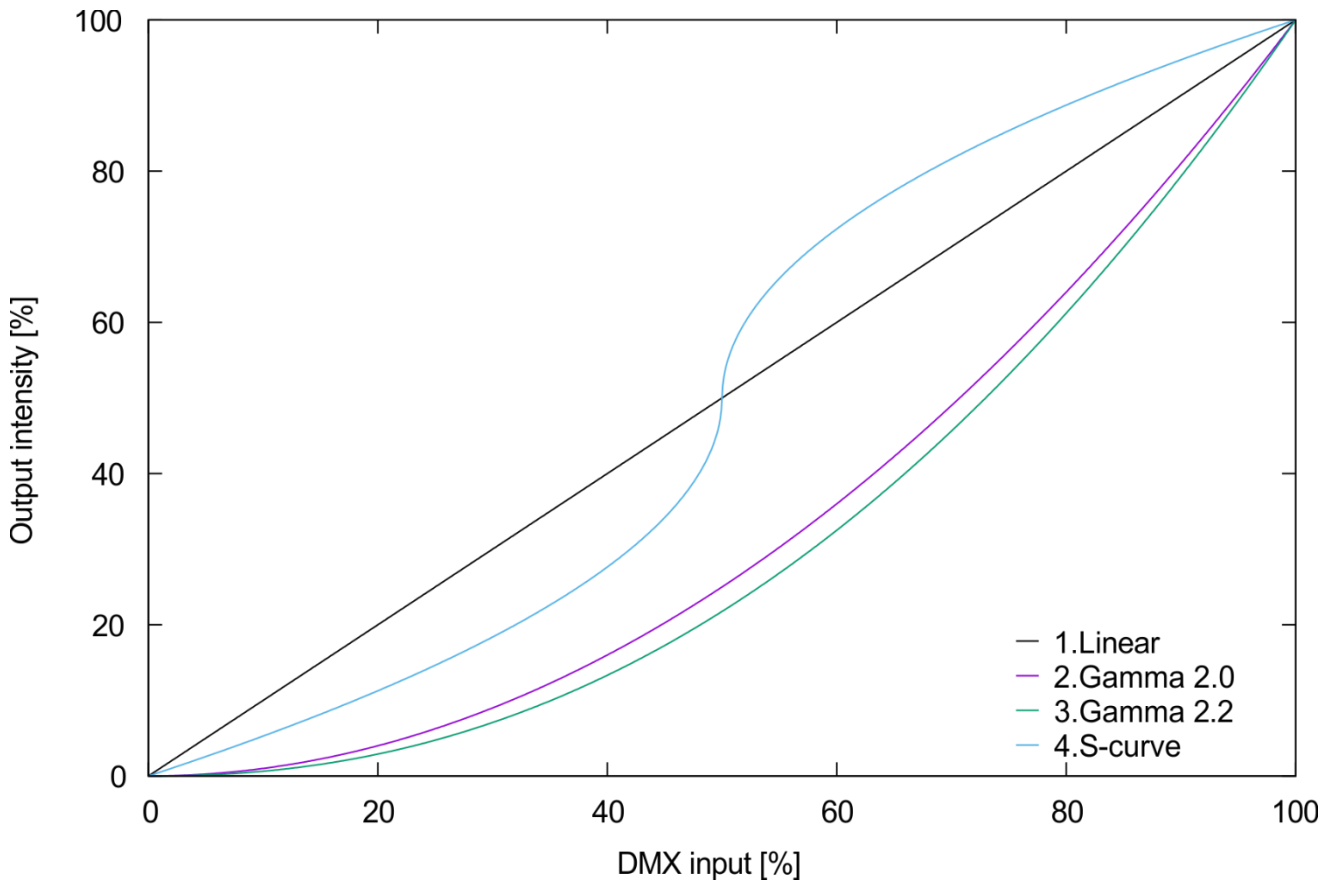

- 04) Press the **ENTER** button to confirm.

5. Dimmer Speed

In this menu you can set the dimmer speed.

- 01) While in the main menu, press the **UP/DOWN** buttons until the display shows Menu
Dimmer Speed.
- 02) Press the **ENTER** button to open the menu.
- 03) Press the **UP/DOWN** buttons to set the dimmer speed. Choose one of the 4 options



- 04) Press the **ENTER** button to confirm.

6. DMX Lost Mode

In this menu you can determine the behaviour of the Fresnel in case of a DMX failure.

- 01) While in the main menu, press the **UP/DOWN** buttons until the display shows .
- 02) Press the **ENTER** button to open the menu.
- 03) Press the **UP/DOWN** buttons to choose one of the 3 options:

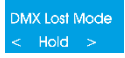

The device will fall back on the last properly working DMX signal from before the DMX signal error, which ensures uninterrupted performance.



The device will black out in case of a DMX failure.

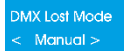

The device will fall back on the last working settings from Manual mode.

- 04) Press the **ENTER** button to confirm.

7. Fan Mode

In this menu you can control the speed of the fan.

- 01) While in the main menu, press the **UP/DOWN** buttons until the display shows .
- 02) Press the **ENTER** button to open the menu.
- 03) Press the **UP/DOWN** buttons to set the speed of the fan. Choose one of the 3 options



Up/Down



Up/Down



- 04) Press the **ENTER** button to confirm.

8. PWM Frequency

In this menu you can set the PWM frequency.

- 01) While in the main menu, press the **UP/DOWN** buttons until the display shows .
- 02) Press the **ENTER** button to open the menu.
- 03) Press the **UP/DOWN** buttons to set the device's PWM frequency. The adjustment range is between

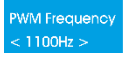

Up/Down



, in increments of 10Hz.

- 04) Press the **ENTER** button to confirm.

9. Display

In this menu you can set the backlight of the display.

- 01) While in the main menu, press the **UP/DOWN** buttons until the display shows .
- 02) Press the **ENTER** button to open the menu.
- 03) Press the **UP/DOWN** buttons to choose one of the 3 options:



The display will turn off in 60 seconds.



The display will be continuously on.





The display will be off.

- 04) Press the **ENTER** button to confirm your choice

10. Zoom Motor





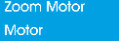

In this menu you can set the manual settings from the zoom motor.

- 01) While in the main menu, press the **UP/DOWN** buttons until the display shows .
- 02) Press the **ENTER** button to open the submenu.
- 03) Press the **UP/DOWN** buttons to choose between 3 options:



-  Reset motor
-  Encode
-  Enable motor

- 04) Press the **ENTER** button to confirm.

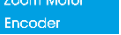
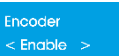

10.1 Reset Motor

- 01) Press the **UP/DOWN** buttons until the display shows .
- 02) Press the **ENTER** button to open the submenu.
- 03) Press the **UP/DOWN** buttons to choose between  or .
- 04) Press the **ENTER** button again to reset the motor, the display will show .
- 05) Press the **ENTER** button to confirm the reset of the motor, the display will show .
- 06) If you choose , the motor will not be reset.

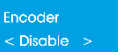
10.2 Encoder

- 01) Press the **UP/DOWN** buttons until the display shows .
- 02) Press the **ENTER** button to open the submenu.
- 03) Press the **UP/DOWN** buttons to choose between  or .
- 04) Press the **ENTER** button to confirm.
- 05) If you choose , there will be no motor errors visible in the software when something blocks the motor or if you manually move the zoom control while the device is operated by DMX.

10.3 Enable Motor

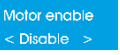
- 01) Press the **UP/DOWN** buttons until the display shows .
- 02) Press the **ENTER** button to open the submenu.
- 03) Press the **UP/DOWN** buttons to choose between  or .
- 04) Press the **ENTER** button to confirm.
- 05) If you choose , it will completely turn off the electrical part of the motor, so you can only control the zoom manually.

11. Info

In this menu you can view the information about the device.

- 01) While in the main menu, press the **UP/DOWN** buttons until the display shows .
- 02) Press the **ENTER** button to open the menu.
- 03) The display will show:

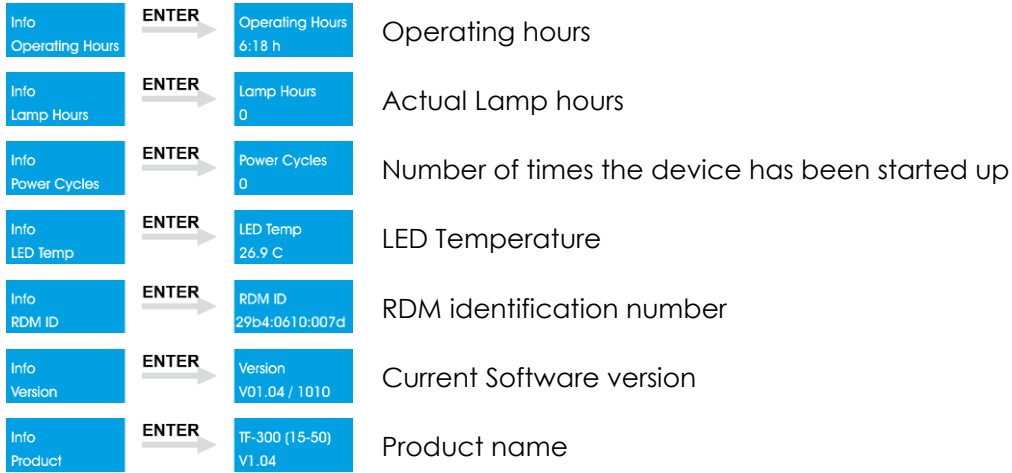



- 04) Press the **UP/DOWN** buttons to scroll through the options.
- 05) Press the **ENTER** button to confirm.

12. Reset Factory Settings

In this menu you can reset to the default settings.

- 01) While in the main menu, press the **UP/DOWN** buttons until the display shows .
- 02) Press the **ENTER** button to open the menu.

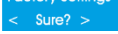
- 03) Press the **UP/DOWN** buttons to choose between   .
- 04) Press the **ENTER** button to confirm your choice.

05) If you choose , the device will not reset to its default settings.

06) If you choose , press the **ENTER** button to confirm.

07) The device will now reset to its default settings.

DMX Channels

1 Channel (Dimmer)

Channel 1 – Dimmer

0-255 Dimmer intensity, from dark to brightest 0-100%

3 Channels (Basic)

Channel 1 – Dimmer

0-255 Dimmer intensity, from dark to brightest 0-100%

Channel 2 – Shutter/Strobe

0-5 Closed

6-249 Strobe, from low to high frequency

250-255 Open

Channel 3 – Zoom

0-255 Gradual zoom adjustment, from small to big

5 Channels (Pro)

Channel 1 – Dimmer High

0-255 Dimmer intensity, from dark to brightest 0-100%

Channel 2 – Dimmer Low

0-255 Dimmer intensity, from dark to brightest 0-100%

Channel 3 – Shutter/Strobe

0-5 Closed

6-249 Strobe, from low to high frequency

250-255 Open

Channel 4 – Zoom

0-255 Gradual zoom adjustment, from small to big

Channel 5 – Control mode (CH1 must be set between 1-255 and CH3 between 6-255 (Hold DMX value for at least 3 sec. before the function takes effect)

0-7 No function

8-15 Dimmer curve 1: Linear

16-23 Dimmer curve 2: Gamma 2.0

24-31 Dimmer curve 3: Gamma 2.2

32-39 Dimmer curve 4: S-curve

40-47 Dimmer speed 1: Auto

48-55 Dimmer speed 2: Slow

56-63 Dimmer speed 3: Medium

64-71 Dimmer speed 4:Fast

72-103 No function

104-111 PWM speed: 1,1 kHz

112-119 PWM speed: 1,2 kHz

120-127 PWM speed: 1,3 kHz

128-135 PWM speed: 1,4 kHz

136-143 PWM speed: 1,5 kHz

144-151 PWM speed: 1,6 kHz

152-159 Calibration disabled

160-167 Calibration enabled

168-175 Fan mode: silent

| | |
|---------|---------------------------|
| 176-183 | Fan mode: auto |
| 184-191 | Fan mode: full |
| 192-199 | Graphic display: auto off |
| 200-207 | Graphic display: on |
| 208-223 | No function |
| 224-231 | Zoom motor reset |
| 232-249 | No function |
| 250 | Reset all |
| 251-255 | No function |

Maintenance

The Showtec Infinity TF-300 Fresnel requires almost no maintenance. However, you should keep the unit clean. Otherwise, the fixture's light output will be significantly reduced. Disconnect the mains power supply and then wipe the cover with a damp cloth. The front glass panel will require weekly cleaning, as smoke-fluid tends to build up residues, reducing the light output very quickly. Do not immerse in liquid. Keep connections clean. Disconnect electric power, and then wipe the DMX and audio connections with a damp cloth. Make sure connections are thoroughly dry before linking equipment or supplying electric power.

The operator has to make sure that safety-related and machine-technical installations are to be inspected by an expert after every year in the course of an acceptance test.

The operator has to make sure that safety-related and machine-technical installations are to be inspected by a skilled person once a year.

The following points have to be considered during the inspection:

- 01) All screws used for installing the device or parts of the device have to be tightly connected and must not be corroded.
- 02) There may not be any deformations on housings, fixations and installation spots.
- 03) Mechanically moving parts like axles, eyes and others may not show any traces of wearing.
- 04) The electric power supply cables must not show any damages or material fatigue.

Cleaning the Field Lens

Use a clean micro-fiber cloth to clean the lens. You can use isopropyl alcohol on the cloth. Do not spray the cleaning solution directly onto the lens or the interior of the device.

Troubleshooting

No Light

This troubleshooting guide is meant to help solve simple problems.

If a problem occurs, carry out the steps below in sequence until a solution is found. Once the unit operates properly, do not carry out following steps.

If the light effect does not operate properly, refer servicing to a technician.

Suspect four potential problem areas as: factory reset, the power supply, the LEDs, the internal fuse.

- 01) First try to reset the device to its original factory default settings (**12. Reset Factory Settings**, see page 22).
- 02) Power supply. Check that the unit is plugged into an appropriate power supply.
- 03) The LEDs. Return the Fresnel to your Infinity dealer.
- 04) The internal fuse. Return the Fresnel to your Infinity dealer.
- 05) If all of the above appears to be O.K., plug the unit in again.
- 06) If you are unable to determine the cause of the problem, do not open the Fresnel, as this may damage the unit and the warranty will become void.
- 07) Return the device to your Infinity dealer.

No Response to DMX

Suspect the DMX cable or connectors, a controller malfunction, a light effect DMX card malfunction.

- 01) Check the DMX setting. Make sure that DMX addresses are correct.
- 02) Check the DMX cable: Unplug the unit; change the DMX cable; then reconnect to electrical power. Try your DMX control again.
- 03) Determine whether the controller or light effect is at fault. Does the controller operate properly with other DMX products ? If not, take the controller in for repair. If so, take the DMX cable and the light effect to a qualified technician.

| Problem | Probable cause(s) | Remedy |
|--|---|--|
| One or more fixtures do not function at all | No power to the fixture | <ul style="list-style-type: none"> ● Check if power is switched on and cables are plugged in |
| | Internal fuse blown | <ul style="list-style-type: none"> ● Return the Fresnel to your Infinity dealer |
| Fixtures reset correctly, but all respond erratically or not at all to the controller | The controller is not connected | <ul style="list-style-type: none"> ● Connect controller |
| | 3-pin/5-pin XLR Out of the controller does not match XLR Out of the first fixture on the link (i.e. signal is reversed) | <ul style="list-style-type: none"> ● Install a phase reversing cable between the controller and the first fixture on the link |
| Fixtures reset correctly, but some respond erratically or not at all to the controller | Poor data quality | <ul style="list-style-type: none"> ● Check data quality. If much lower than 100 percent, the problem may be a bad data link connection, poor quality or broken cables, missing termination plug, or a defective fixture disturbing the link |
| | Bad data link connection | <ul style="list-style-type: none"> ● Inspect connections and cables. Correct poor connections. Repair or replace damaged cables |
| | Data link not terminated with 120 Ohm termination plug | <ul style="list-style-type: none"> ● Insert termination plug in output jack of the last fixture on the link |
| | Incorrect addressing of the fixtures | <ul style="list-style-type: none"> ● Check address setting |
| | One of the fixtures is defective and disturbs data transmission on the link | <ul style="list-style-type: none"> ● Bypass one fixture at a time until normal operation is regained: unplug both connectors and connect them directly together ● Have the defective fixture serviced by a qualified technician |
| | 3-pin XLR Out on the fixtures does not match (pins 2 and 3 reversed) | <ul style="list-style-type: none"> ● Install a phase-reversing cable between the fixtures or swap pin 2 and 3 in the fixture that behaves erratically |
| No light or LEDs cut out intermittently | Fixture is too hot | <ul style="list-style-type: none"> ● Allow fixture to cool ● Clean fan ● Make sure air vents are not blocked ● Turn up the air conditioning |
| | LEDs damaged | <ul style="list-style-type: none"> ● Disconnect fixture and return to your dealer |
| | The power supply settings do not match local AC voltage and frequency | <ul style="list-style-type: none"> ● Disconnect fixture. Check settings and correct if necessary |

Product Specifications

| | |
|--|---|
| Model: | Infinity TF-300 Fresnel |
| Input Voltage: | 100-240V AC, 50/60Hz |
| Power consumption: | 300W |
| Power factor: | 0,97 |
| DMX linking: | 30 pcs |
| Dimensions: | 509 x 322 x 450 mm (LxWxH) (incl. bracket) |
| Weight: | 8,3 kg |
| Operating and Programming: | |
| Signal pin OUT: | Pin 1 (earth), pin 2 (-), pin 3 (+) |
| DMX Mode: | 1, 3 or 5 channels |
| Signal input: | 3-pin/5-pin XLR IN |
| Signal output: | 3-pin/5-pin XLR OUT |
| Electro-mechanical effects: | |
| Light source: | 300W Lumiled White LED |
| Light output: | 5000lm |
| CRI: | Consistently > 96% |
| Color Temperature: | 3200K |
| Beam angle: | 15°-50° |
| Dimmer: | 0-100% |
| Strobe: | 0-20Hz |
| Dimming Curves: | Linear, Gamma 2.0, Gamma 2.2, S-curve |
| Housing: | Aluminum, sheet metal, molded engineering grade plastics |
| Color: | Black |
| IP rating: | IP20 |
| Ambient temperature: | 0°-40° (operating) |
| Startup temperature: | -10°-45° |
| DMX control: | via standard DMX/RDM controller |
| Onboard: | LCD display |
| Control: | DMX-512, Manual control |
| Connections: | Neutrik PowerCON IN/OUT, Neutrik 3-pin XLR data IN/OUT, Neutrik 5-pin XLR data IN/OUT |
| Max. ambient temperature (operating) t_a : | 0°-40°C |
| Startup temperature: | -10°-45°C |
| Max. housing temperature t_B : | 80°C |
| Minimum distance: | |
| Minimum distance from flammable surfaces: | 0,5 m |
| Minimum distance to lighted object: | 1,5 m |

Design and product specifications are subject to change without prior notice.



Website: www.Showtec.info
 Email: service@highlite.com

Dimensions

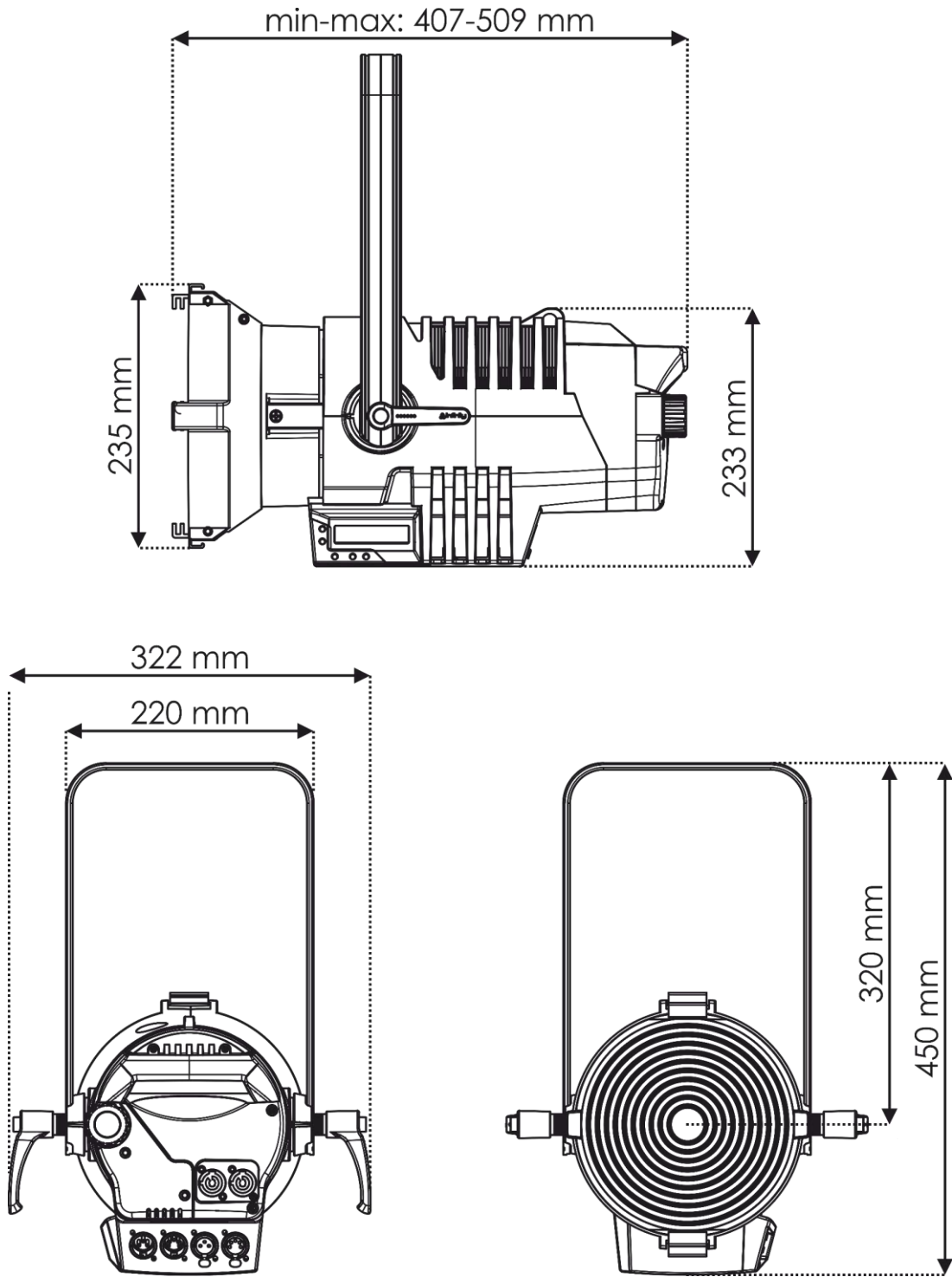



©2019 Infinity