

# MICSET-D32J, MICSET-D32JSE, MICSET-D32XLR

DYNAMIC DESKTOP MICROPHONE

MICRÓFONO DINÁMICO DE SOBREMESA



QUICK START GUIDE/GUÍA RÁPIDA/  
GUIDE DE DÉMARRAGE RAPIDE/GUIA RÁPIDO

## **FONESTAR**

### DESCRIPTION/DESCRIPCIÓN/DESCRIPTION/DESCRIÇÃO

#### EN

- Unidirectional dynamic desktop microphone
- Flexo length: 32 cm
- **MICSET-D32J** 6.3 mm mono jack connector
- MICSET-D32JSE** 6.3 mm mono jack plug and stripped ends
- MICSET-D32XLR** XLR connector (unbalanced)

#### ES

- Micrófono dinámico unidireccional de sobremesa
- Longitud del flexo: 32 cm
- **MICSET-D32J** conector jack 6'3 mm mono
- MICSET-D32JSE** conector jack 6'3 mm mono y puntas peladas
- MICSET-D32XLR** conector XLR (desbalanceado)

#### FR

- Microphone dynamique unidirectionnel de table
- Longueur flexo : 32 cm
- **MICSET-D32J** prise jack mono 6'3 mm
- MICSET-D32JSE** prise jack mono 6'3 mm et broches dénudées
- MICSET-D32XLR** connecteur XLR (asymétrique)

#### PT

- Microfone dinâmico unidireccional de mesa
- Comprimento da haste flexível: 32 cm
- **MICSET-D32J** conetor jack 6,3 mm mono
- MICSET-D32JSE** conetor jack 6,3 mm mono e pontas descarnadas
- MICSET-D32XLR** conetor XLR (não balanceado)

## CONTROLS/CONTROLES/CONTRÔLES/CONTROLOS

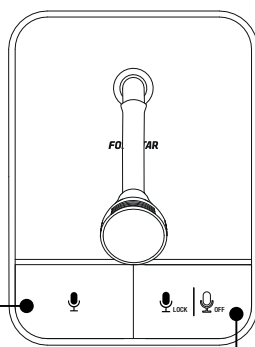

- EN** LOCK/OFF (PTL) button to activate/deactivate the microphone.  
Press the button to speak and press again to deactivate the microphone.
- ES** Pulsador LOCK/OFF (PTL) para activar/desactivar el micrófono.  
Pulse el botón para hablar y vuelva a pulsar para desactivar el micrófono.
- FR** La touche LOCK/OFF (PTL) permet d'activer/désactiver le microphone.  
Appuyez sur la touche pour parler et appuyez à nouveau pour désactiver le microphone.
- PT** Botão LOCK/OFF (PTL) para ativar/desativar o microfone.  
Prima o botão para falar e prima novamente para desativar o microfone.

- EN** Push button (PTT) to activate/deactivate the microphone.  
Press and hold the button to speak. It will remain deactivated if not pressed.
- ES** Pulsador (PTT) para activar/desactivar el micrófono.  
Mantenga pulsado el botón para hablar. Se mantendrá desactivado si no se pulsa.
- FR** Appuyez sur le bouton (PTT) pour activer/désactiver le microphone.  
Appuyez sur le bouton et maintenez-le enfoncé pour parler. Il reste désactivé s'il n'est pas enfoncé.
- PT** Prima o botão (PTT) para ativar/desativar o microfone.  
Prima e mantenha premido o botão para falar. Permanecerá desativado se não for premido.

## PIN OUT

### MICSET-D45J

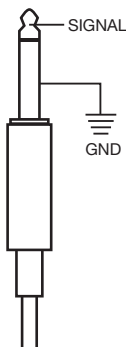
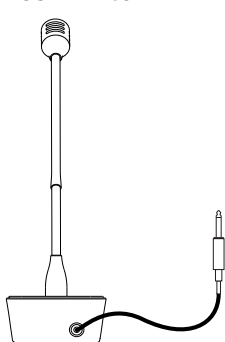

### MICSET-D45JSE

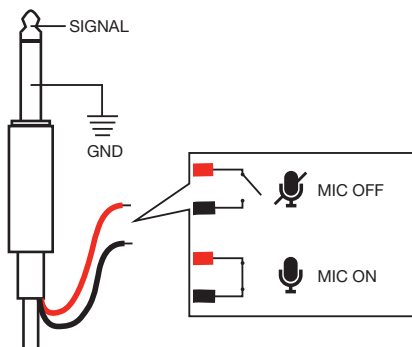
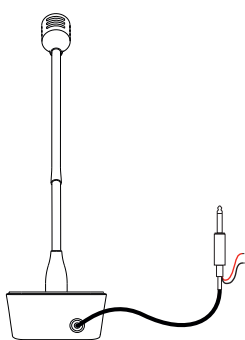

### MICSET-D45XLR

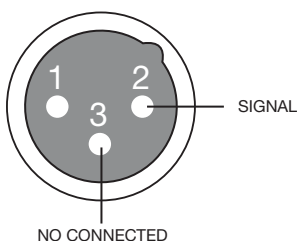
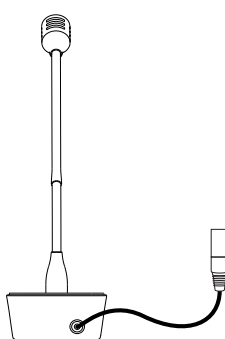

# TECHNICAL SPECIFICATIONS/ESPECIFICACIONES TÉCNICAS/ SPÉCIFICATIONS TECHNIQUES/ESPECIFICAÇÕES TÉCNICAS

|                   |  |
|-------------------|--|
| <b>EN</b>         |  |
| CAPSULE           | Unidirectional dynamic   |
| RESPONSE          | 100-15.000 Hz  |
| SENSITIVITY       | -55 dB $\pm$ 3 dB (V/Pa) a 1 kHz   |
| IMPEDANCE         | 600 $\Omega$   |
| SPL MAX           | 110dB  |
| EQUIVALENT NOISE  | 32 dB  |
| DYNAMIC RANGE     | 78 dB  |
| DISTORTION        | < 1 %  |
| SNR               | 75 dB  |
| PUSH BUTTON       | ON-OFF/PTT   |
| TEMPERATURE       | Operating temperature: -20° C - 50° C<br>Storage temperature: -25° C - 70° C<br>Relative humidity: 0 - 90 %  |
| CONNECTORS        | <b>MICSET-D32J</b> : 6.3 mm mono jack<br><b>MICSET-D32JSE</b> : 6.3 mm mono jack connection and stripped ends for contact closure<br><b>MICSET-D32XLR</b> : XLR male 3 pin   |
| DIMENSIONS        | Gooseneck: 32 cm high<br>Desktop base: 93 x 46 x 122 mm depth  |
| CABLE             | <b>MICSET-D32J</b> : 1.5 m with 6.3 mm mono jack connector<br>Unbalanced line<br><b>MICSET-D32JSE</b> : 1.5 m with 6.3 mm mono jack plug and stripped ends<br>Unbalanced line<br><b>MICSET-D32XLR</b> : 5 m with 3-pin XLR male connector<br>Unbalanced line                     |
| <b>ES</b>         |  |
| CÁPSULA           | Dinámica unidireccional  |
| RESPUESTA         | 100-15.000 Hz  |
| SENSIBILIDAD      | -55 dB $\pm$ 3 dB (V/Pa) a 1 kHz   |
| IMPEDANCIA        | 600 $\Omega$   |
| SPL MAX           | 110dB  |
| RUIDO EQUIVALENTE | 32 dB  |
| RANGO DINÁMICO    | 78 dB  |
| DISTORSIÓN        | < 1 %  |
| SNR               | 75 dB  |
| PULSADOR          | ON-OFF/PTT   |
| TEMPERATURA       | Temperatura de funcionamiento:<br>-20° C - 50° C<br>Temperatura de almacenamiento:<br>-25° C - 70° C<br>Humedad relativa: 0 - 90 %   |
| CONECTORES        | <b>MICSET-D32J</b> : Jack 6'3 mm mono<br><b>MICSET-D32JSE</b> : Conexión Jack 6'3 mm mono y puntas peladas para cierre de contactos<br><b>MICSET-D32XLR</b> : XLR macho 3 pin  |
| MEDIDAS           | Flexo: 32 cm alto<br>Base de sobremesa: 93 x 46 x 122 mm fondo   |
| CABLE             | <b>MICSET-D32J</b> : 1'5 m con conector jack 6'3 mm mono<br>Línea desbalanceada<br><b>MICSET-D32JSE</b> : 1'5 m con conector Jack 6'3 mm mono y puntas peladas<br>Línea desbalanceada<br><b>MICSET-D32XLR</b> : 5 m con conector XLR macho 3 pin<br>Línea desbalanceada          |
| <b>FR</b>         |  |
| CAPSULE           | Dynamique unidirectionnel  |
| RÉPONSE           | 100-15.000 Hz  |
| SENSIBILITÉ       | -55 dB $\pm$ 3 dB (V/Pa) a 1 kHz   |
| IMPÉDANCE         | 600 $\Omega$   |
| SPL MAX           | 110dB  |
| BRUIT ÉQUIVALENT  | 32 dB  |
| GAMME DYNAMIQUE   | 78 dB  |
| DISTORSION        | < 1 %  |
| SNR               | 75 dB  |
| BOUTON POUSSOIR   | ON-OFF/PTT   |
| TEMPERATURE       | Température de fonctionnement :<br>-20 °C - 50 °C<br>Température de stockage : -25° C - 70° C<br>Humidité relative : 0 - 90 %.   |
| CONNECTEURS       | <b>MICSET-D32J</b> : Connexion Jack 6'3 mm mono y puntas peladas para cierre de contactos<br><b>MICSET-D32JSE</b> : Connexion jack mono 6'3 mm et broches dénudées pour la fermeture des contacts<br><b>MICSET-D32XLR</b> : XLR mâle à 3 broches                                 |
| MESURES           | Lampe de bureau : 32 cm de haut<br>Base du plateau : 93 x 46 x 122 mm de profondeur  |
| CÂBLE             | <b>MICSET-D32J</b> : 1'5 m avec connecteur jack mono 6'3 mm<br>Ligne asymétrique<br><b>MICSET-D32JSE</b> : 1'5 m avec fiche jack mono 6'3 mm et extrémités dénudées<br>Ligne asymétrique<br><b>MICSET-D32XLR</b> : 5 m avec connecteur XLR mâle à 3 broches<br>Ligne asymétrique |

|                   |   |
|-------------------|---|
| PT                | Dinâmica unidireccional   |
| CÁPSULA           | 100-15.000 Hz   |
| RESPOSTA          | -55 dB ±3 dB (V/Pa) a 1 kHz   |
| SENSIBILIDADE     | 600 Ω   |
| IMPEDÂNCIA        | 110dB   |
| SPL MAX           | 32 dB   |
| RUÍDO EQUIVALENTE | 78 dB   |
| VARIAÇÃO DINÂMICA | < 1 %   |
| DISTORÇÃO         | 75 dB   |
| SNR               | ON-OFF/PTT  |
| BOTÃO             | Temperatura de funcionamento: -20° C - 50° C  |
| TEMPERATURA       | Temperatura de armazenamento: -25° C - 70° C  |
|                   | Humidade relativa: 0 - 90 %   |
|                   | <b>MICSET-D32J:</b> Jack 6,3 mm mono  |
| CONECTORES        | <b>MICSET-D32JSE:</b> Ligação Jack 6,3 mm mono e pontas descarnadas para fecho de contactos |
|                   | <b>MICSET-D32XLR:</b> XLR macho 3 pin   |
|                   | Haste flexível: 32 cm altura  |
| MEDIDAS           | Base de mesa: 93 x 46 x 122 mm profundidade   |
|                   | <b>MICSET-D32J:</b> 1,5 m com conetor jack 6,3 mm mono                                      |
| CABO              | Linha não balanceada  |
|                   | <b>MICSET-D32JSE:</b> 1,5 m com conetor jack 6,3 mm mono em Y pontas descarnadas            |
|                   | Linha não balanceada  |
|                   | <b>MICSET-D32XLR:</b> 5 m com conetor XLR macho 3 pin                                       |
|                   | Linha não balanceada  |