

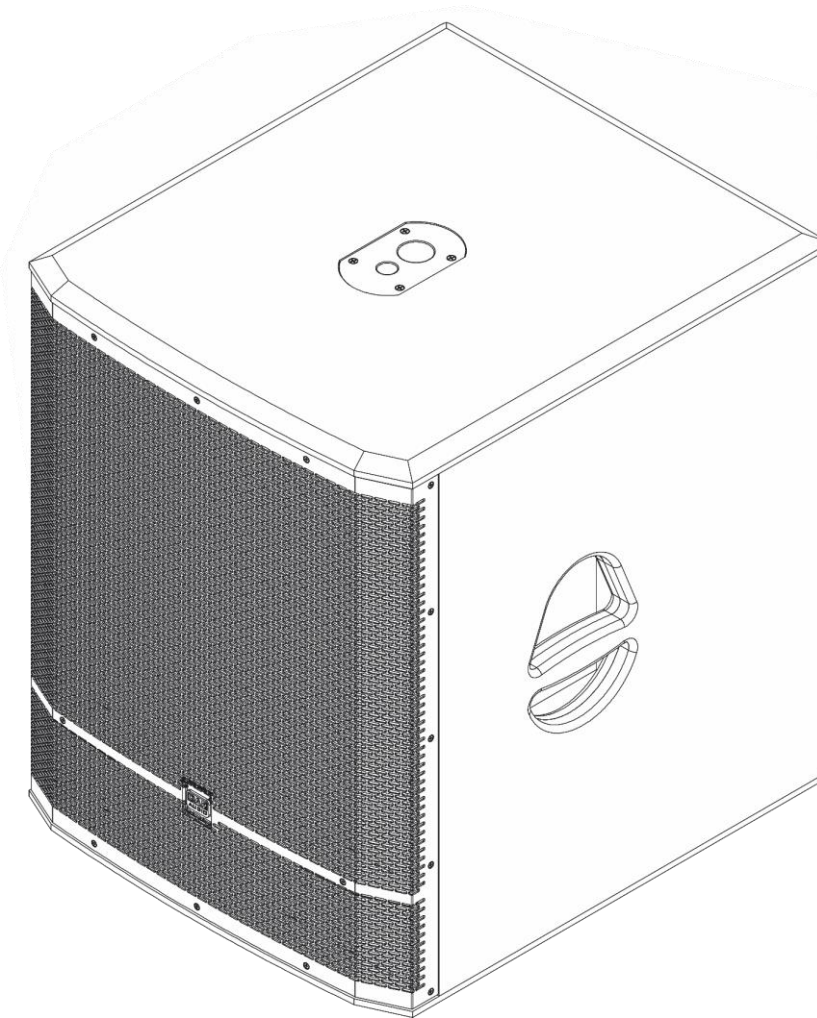

# MANUAL



**ENGLISH**

**Pure-18S Passive 18" Subwoofer**

**V1**

**Order code: D3744**

## Table of contents

---

<b>Warning</b> .....	2
Safety Instructions .....	2
Operating Determinations .....	4
Connection with the mains.....	4
Return Procedure .....	4
Claims.....	4
<b>Description of the device</b> .....	5
Overview .....	6
Back.....	6
<b>Installation</b> .....	7
<b>Setup and Operation</b> .....	8
Connection Example 1 (2 x Pure-10/Pure-12/Pure-15 and 2 x Pure-15S/Pure-18S).....	8
Connection Example 2 (2 x Pure-10/Pure-12/Pure-15 and 4 x Pure-15S/Pure-18S).....	9
<b>Connection Cables</b> .....	10
<b>Maintenance</b> .....	10
<b>Troubleshooting</b> .....	10
No Sound .....	10
Sound Warping.....	10
<b>Product Specifications</b> .....	11
<b>Notes</b> .....	12

## Warning



**For your own safety, please read this user manual carefully  
before your initial start-up!**



### Unpacking Instructions

Immediately upon receiving this product, carefully unpack the carton and check the contents to ensure that all parts are present, and have been received in good condition. Notify the dealer immediately and retain packing material for inspection if any parts appear damaged from shipping or the carton itself shows signs of mishandling. Save the carton and all packing materials. In the event that a fixture must be returned to the factory, it is important that the fixture be returned in the original factory box and packing.

### Your shipment includes:

- DAP Audio Pure-18S Passive 18" Subwoofer
- User manual

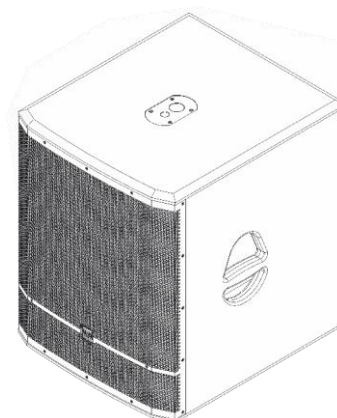

**CAUTION!**  
**Keep this device away from rain and moisture!**  
**Unplug mains lead before opening the housing!**



### Safety Instructions

Every person involved with the installation, operation and maintenance of this system has to:

- be qualified
- follow the instructions of this manual



**CAUTION! Be careful with your operations.**  
**With a dangerous voltage you can suffer  
a dangerous electric shock when touching the wires!**



Before your initial start-up, please make sure that there is no damage caused by transportation. Should there be any, consult your dealer and do not use the system.

To maintain perfect condition and to ensure a safe operation, it is absolutely necessary for the user to follow the safety instructions and warning notes written in this manual.

Please consider that damages caused by manual modifications to the system are not subject to warranty.

This system contains no user-serviceable parts. Refer servicing to qualified technicians only.

### IMPORTANT:

The manufacturer will not accept liability for any resulting damages caused by the non-observance of this manual or any unauthorized modification to the system.

- Always disconnect power from the mains, when system is not used. Only handle the power cord by the plug. Never pull out the plug by tugging the power cord.
- Always operate the unit with the AC ground wire connected to the electrical system ground.
- Avoid flames and do not put close to flammable liquids or gases.
- Avoid ground loops! Always be sure to connect the power amps and the mixing console to the same electrical circuit to ensure the same phase!
- Avoid installing your equipment very near radio or TV sets, mobile phones, etc., as these can cause RF (radio frequency) interference.
- Avoid loud feedback from microphones. This can damage your speaker.
- Before changing your grounds around, always turn your amplifiers down.
- Do not connect this device to a dimmer pack.
- Do not drive the inputs with a signal level higher than required to drive the equipment to full output.
- Do not open this device. Risk: hazardous radiation exposure.
- Do not open the device and do not modify the device.
- Do not switch the system on and off in short intervals, as this would reduce the system's life.
- Extreme frequency boosts in connection with a high input signal level may lead to overdriving your equipment. Should this occur, it is necessary to reduce the input signal level by using the INPUT control.
- If device is dropped or struck, disconnect mains power supply immediately. Have a qualified engineer inspect for safety before operating.
- If the system has been exposed to drastic temperature fluctuation (e.g. after transportation), do not switch it on immediately. The arising condensation water might damage your system. Leave the system switched off until it has reached room temperature.
- If your DAP Audio device fails to work properly, discontinue use immediately. Pack the unit securely (preferably in the original packing material), and return it to your DAP Audio dealer for service.
- Make sure that the available voltage is not higher than stated on the rear panel.
- Make sure that the power cord is never crimped or damaged. Check the device and the power cord from time to time.
- Make sure that the signals into the mixer are balanced, otherwise hum could be created.
- Make sure that there is sufficient room on all sides of the system for air circulation.
- Make sure you do not use the wrong kind of cables or defective cables.
- Make sure you use DI boxes to balance unbalanced signals; All incoming signals should be clear.
- Never let the power cord come into contact with other cables! Handle the power cord and all connections with the mains with particular caution!
- Never remove warning or informative labels from the unit.
- Never modify, bend, mechanically strain, put pressure on, pull or heat up the power cord.
- Never use anything to cover the ground contact.
- Never use the device during thunderstorms, unplug the device immediately.
- Only use device indoors, avoid contact with water or other liquids.
- Prevent distortion! Make sure that all components connected to the Pure-18S have sufficient power ratings. Otherwise distortion will be generated because the components are operated at their limits.
- Repairs, servicing and electric connection must be carried out by a qualified technician.
- The best way (even if not always feasible) to avoid ground loops is to connect the electric ground of all the equipment to a single central point ("star" system). In this case, the central point can be the mixer.
- To avoid or solve hum and buzzing troubles, try different combinations of lifting grounds on units that are supplied with ground lift switches or make sure all chassis are connected to earth ground, either through the A.C. power cord ground or by the front panel rack mount screws.
- To emphasize a frequency range, you do not necessarily have to move its respective slider upwards; instead, try lowering surrounding frequency ranges. This way, you avoid causing the next piece of equipment in your sound path to overdrive. You also preserve valuable dynamic reserve ("headroom").
- The user is responsible for correct positioning and operating of this product. The manufacturer will not accept liability for damages caused by the misuse or incorrect installation of this device.
- When connecting the other parts of your sound system, watch out for the so-called "ground loops".
- Please read this manual carefully and keep it for future reference.
- WARRANTY: Till one year after date of purchase.

## Operating Determinations

This system is not designed for permanent operation. Consistent operation breaks will ensure that the system will serve you for a long time without defects.

If this system is operated in any other way than the one described in this manual, the product may suffer damages and the warranty becomes void.

Any other operation may lead to dangers like short-circuit, burns, electric shock, etc.

*You endanger your own safety and the safety of others!*

*Improper installation can cause serious injuries and damage of property!*

## Connection with the mains

Connect the device to the mains with the power-plug.

Always pay attention, that the right color cable is connected to the right place.

International	EU Cable	UK Cable	US Cable	Pin
L	BROWN	RED	YELLOW/COPPER	PHASE
N	BLUE	BLACK	SILVER	NEUTRAL
	YELLOW/GREEN	GREEN	GREEN	PROTECTIVE GROUND

*Make sure that the device is always connected properly to the earth!*

*Improper installation can cause serious damage to people and property!*



## Return Procedure



Returned merchandise must be sent prepaid and in the original packing, call tags will not be issued. Package must be clearly labeled with a Return Authorization Number (RMA number). Products returned without an RMA number will be refused. Highlite will not accept the returned goods or any responsibility. Call Highlite 0031-455667723 or mail [aftersales@highlite.com](mailto:aftersales@highlite.com) and request an RMA prior to shipping the fixture. Be prepared to provide the model number, serial number and a brief description of the cause for the return. Be sure to properly pack fixture, any shipping damage resulting from inadequate packaging is the customer's responsibility. Highlite reserves the right to use its own discretion to repair or replace product(s). As a suggestion, proper UPS packing or double-boxing is always a safe method to use.

**Note: If you are given an RMA number, please include the following information on a piece of paper inside the box:**

- 01) Your name
- 02) Your address
- 03) Your phone number
- 04) A brief description of the symptoms

## Claims

The client has the obligation to check the delivered goods immediately upon delivery for any short-comings and/or visible defects, or perform this check after our announcement that the goods are at their disposal. Damage incurred in shipping is the responsibility of the shipper; therefore the damage must be reported to the carrier upon receipt of merchandise.

It is the customer's responsibility to notify and submit claims with the shipper in the event that a fixture is damaged due to shipping. Transportation damage has to be reported to us within one day after receipt of the delivery.

Any return shipment has to be made post-paid at all times. Return shipments must be accompanied with a letter defining the reason for return shipment. Non-prepaid return shipments will be refused, unless otherwise agreed in writing.

Complaints against us must be made known in writing or by fax within 10 working days after receipt of the invoice. After this period complaints will not be handled anymore.

Complaints will only then be considered if the client has so far complied with all parts of the agreement, regardless of the agreement of which the obligation is resulting.

## Description of the device

---

### Features

The DAP Audio Pure-18S is a passive 18" subwoofer which perfectly complements the 10", 12" and 15" units. You have the possibility to set up the sound that matches the requirements of your venue. If you are looking for a way to add Pure bass to your venue, then the Pure-18S is your answer.

- System: Bass-reflex Subwoofer
- Power RMS: 800 W
- Power peak: 1600 W
- Speaker low: 18", 4" Voice coil
- Frequency response (-3 dB): 35–160 Hz
- Frequency response (-10 dB): 32–200 Hz
- Speaker sensitivity: 104 dB / W / m
- Max. SPL @ 1 m: 133 dB
- Speaker impedance: 8  $\Omega$
- Crossover frequency: 125 Hz, 24 dB/Oct BW
- Recommended HPF: 32 Hz, BW-24
- Audio connector: Speakon NL4 IN/OUT/MID-HIGH OUT
- Housing: 18-mm Birch Plywood
- Color: Black, scratch resistant
- Mounting: 35-mm/M20 pole mount
- Dimensions: 600 x 520 x 655 mm (LxWxH)
- Weight: 36,66 kg

### Optional accessories

[D3731](#) – Pure-18(A)S Castor board

[D3740](#) – Pure-10 Passive 10" Full Range

[D3741](#) – Pure-12 Passive 12" Full Range

[D3742](#) – Pure-15 Passive 15" Full Range

[D3743](#) – Pure-15S Passive 15" Subwoofer

[D3783](#) – Transport Cover for Pure-18(A)S

[D4179](#) – HP-3000

[D8610](#) – DAP Distance Tube 35 mm

[D8611](#) – DAP Distance Tube M20

[D8450](#) – DAP Distance Tube 35 mm (max. weight 30 kg)

[FS143](#) – Neutrik Speakon > Speakon speaker cable, 4 x 2,5 mm<sup>2</sup> (3 m)

[FS146](#) – Neutrik Speakon > Speakon speaker cable, 4 x 2,5 mm<sup>2</sup> (6 m)

[FS1410](#) – Neutrik Speakon > Speakon speaker cable, 4 x 2,5 mm<sup>2</sup> (10 m)

[FS1415](#) – Neutrik Speakon > Speakon speaker cable, 4 x 2,5 mm<sup>2</sup> (15 m)

[FS1420](#) – Neutrik Speakon > Speakon speaker cable, 4 x 2,5 mm<sup>2</sup> (20 m)

[FS153](#) – Neutrik Speakon > Speakon speaker cable, 4 x 4 mm<sup>2</sup> (3 m)

[FS156](#) – Neutrik Speakon > Speakon speaker cable, 4 x 4 mm<sup>2</sup> (6 m)

[FS1510](#) – Neutrik Speakon > Speakon speaker cable, 4 x 4 mm<sup>2</sup> (10 m)

[FS1515](#) – Neutrik Speakon > Speakon speaker cable, 4 x 4 mm<sup>2</sup> (15 m)

[FS1520](#) – Neutrik Speakon > Speakon speaker cable, 4 x 4 mm<sup>2</sup> (20 m)

Overview

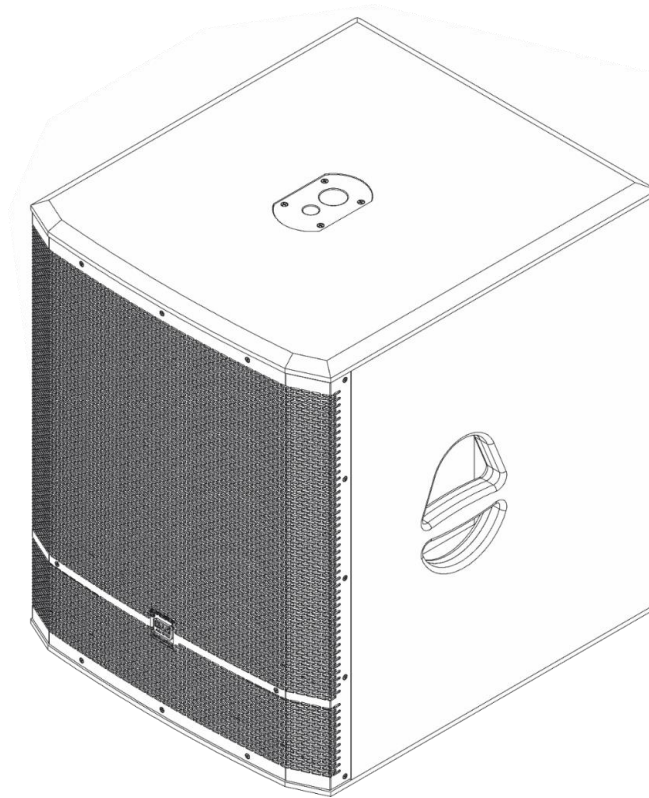

Fig. 01

Back

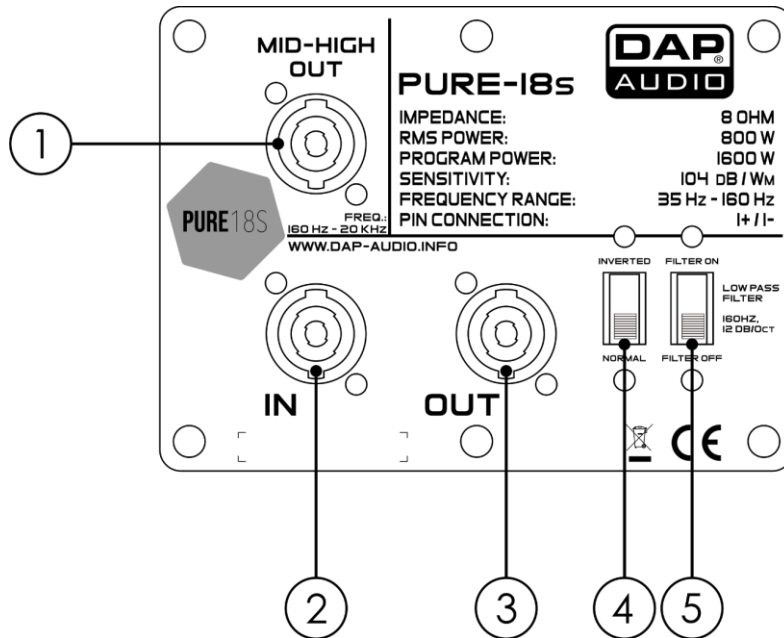

Fig. 02

- 01) **Speakon NL4 MID-HIGH OUT**
- 02) **Speakon NL4 IN**
- 03) **Speakon NL4 OUT**
- 04) **Phase switch**  
Move the switch to select NORMAL or INVERTED.
- 05) **Low-pass filter switch ON/OFF**  
Move the switch to turn the low-pass filter on/off.

## Installation

Remove all packing materials from the Pure-18S. Check if all foam and plastic padding is removed. Connect all cables.

**Do not supply power before the whole system is set up and connected properly.**

**Always disconnect from electric mains power supply before cleaning or servicing.**

**Damages caused by non-observance are not subject to warranty.**

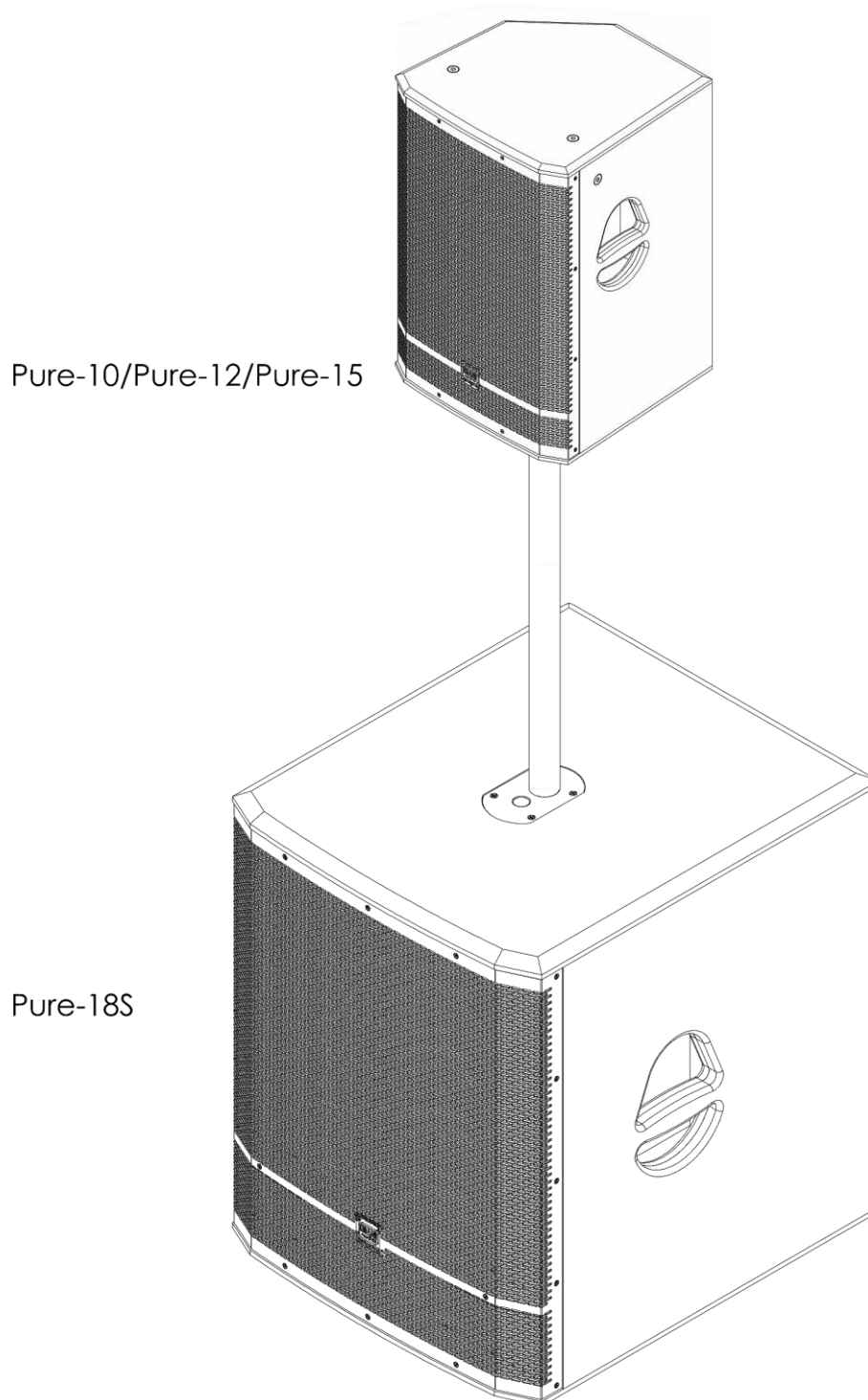

Fig. 03



## Setup and Operation

Follow the directions below, as they pertain to your preferred operation mode. Before plugging the unit in, always make sure that the power supply matches the product specification voltage. Do not attempt to operate a 110 V specification product on 230 V power, or vice versa.

Make your initial connections with all the equipment powered off and ensure that all the main volume controls are turned completely to the minimum. Follow the steps below.

- 01) Connect the speakers to each other, using Speakon cables.
- 02) **Make sure that the low-pass filter (05) is set to ON and phase invert (04) is set to the same direction for all subwoofer cabinets!**
- 03) Connect your mixer to the amplifier.
- 04) Connect power supply to the mixer and the amplifier.

### Connection Example 1 (2 x Pure-10/Pure-12/Pure-15 and 2 x Pure-15S/Pure-18S)

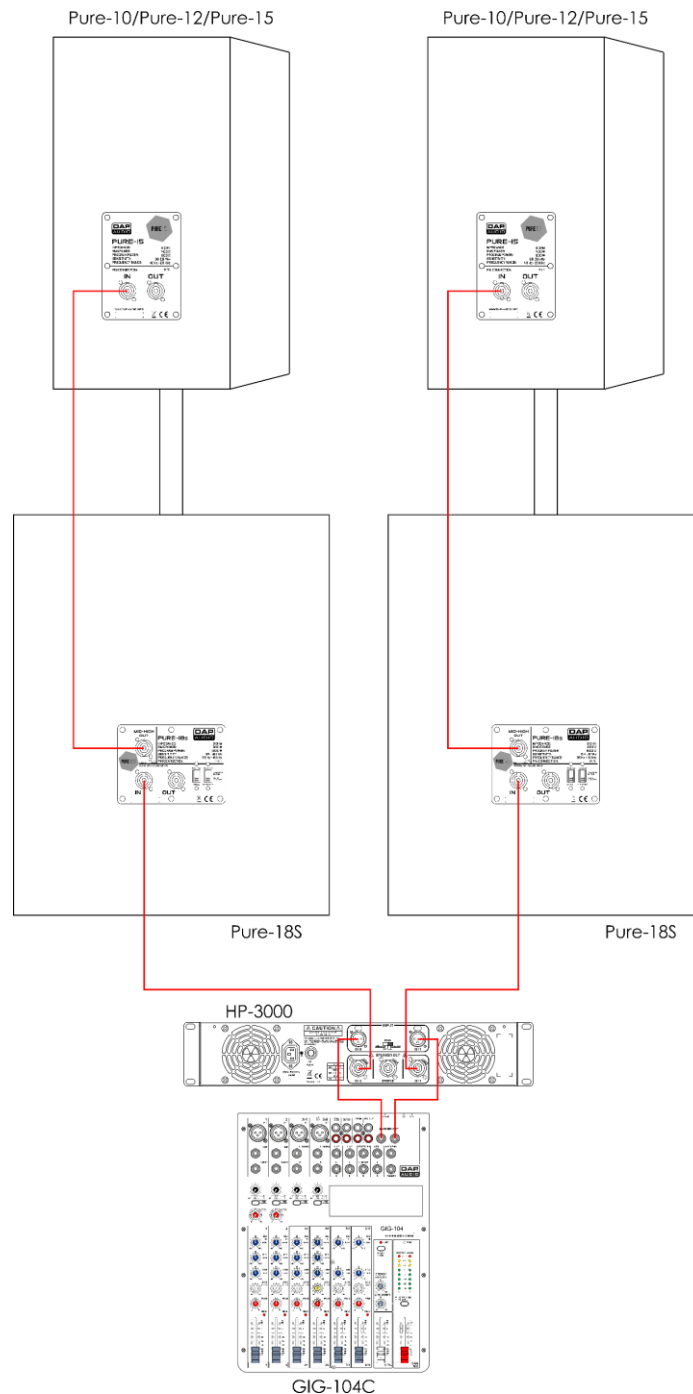

Fig. 04

Connection Example 2 (2 x Pure-10/Pure-12/Pure-15 and 4 x Pure-15S/Pure-18S)

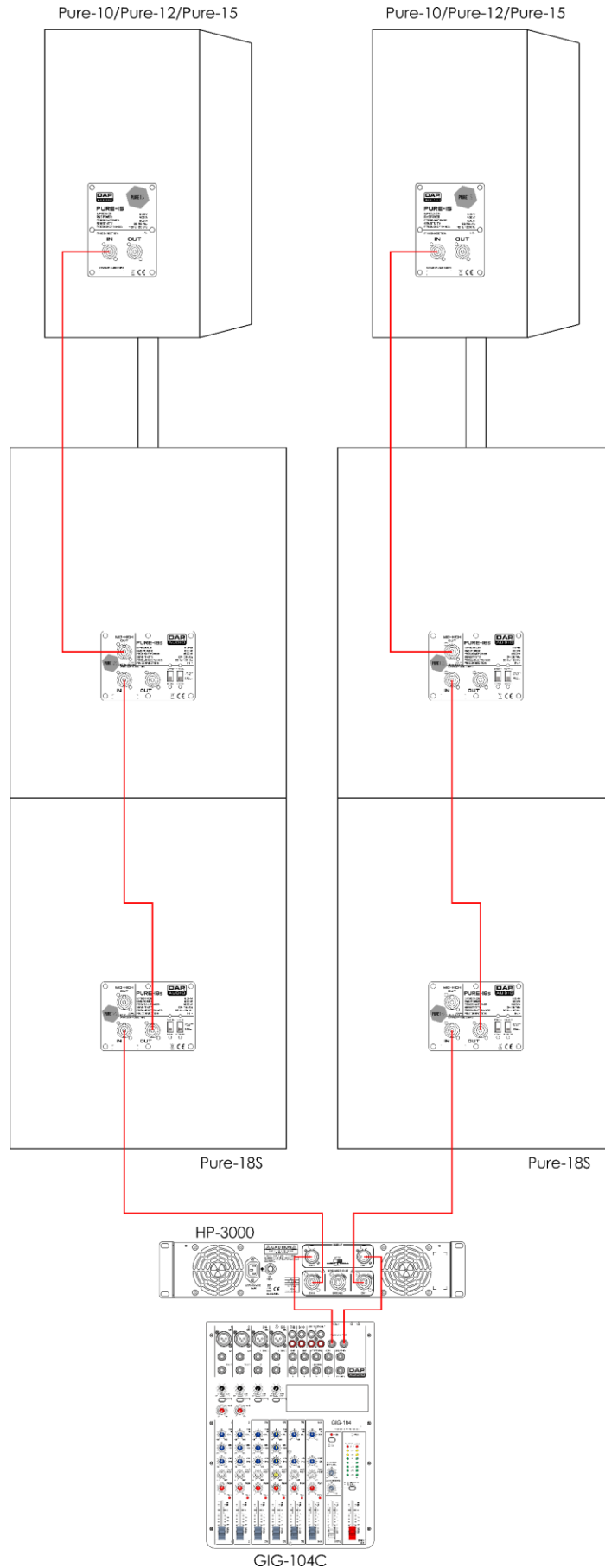
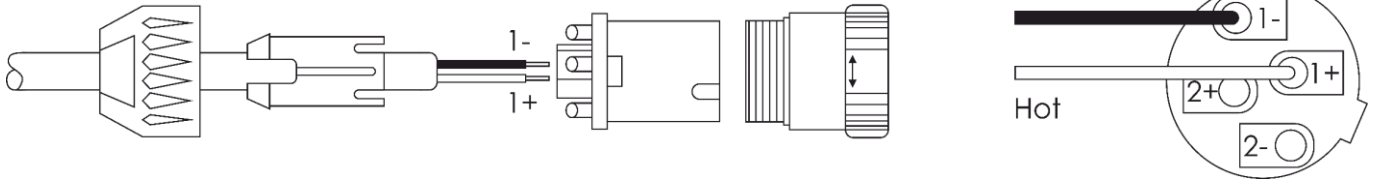

Fig. 05

## Connection Cables

Take care of your cables, always holding them by the connectors and avoiding knots and twists when coiling them: This gives the advantage of increasing their life and reliability. Periodically check your cables. A great number of problems (faulty contacts, ground hum, discharges, etc.) are caused entirely by using unsuitable or faulty cables.

Speakon



Input is a Speakon connector for connecting a speaker-level signal.

Output is a Speakon connector paralleled with the input connector, for daisy-chaining speakers.

Wiring:

Pin 1+ = Signal (+)

Pin 1- = Ground (-)

## Maintenance

The Pure-18S requires almost no maintenance. However, you should keep the unit clean. Disconnect the mains power supply, and then wipe the cover with a damp cloth. Do not immerse in liquid. Do not use alcohol or solvents.

Keep connections clean. Disconnect electric power, and then wipe the connections with a damp cloth. Make sure connections are thoroughly dry before linking equipment or supplying electric power.

## Troubleshooting

### No Sound

Always check if all the cables and cords are connected. Always turn off power to the area before checking the wires, to prevent electric shock.

If everything works properly and there is still no sound, revisit the manufacturer's instructions to make sure they were followed during installation. If everything was installed correctly and there is still no sound, you may want to consider bringing in a professional to take a look at your speaker.

If the speakers do not operate properly, refer servicing to a technician.

Suspect two potential problem areas as: the power supply and the speakers.

01) Power supply. Check if the unit is plugged into an appropriate power supply.

02) The speakers. Return the Pure-18S to your DAP Audio dealer.

03) If all appears to be O.K., plug the unit in again.

04) If you are unable to determine the cause of the problem, do not open the Pure-18S, as this may damage the unit and the warranty will become void.

05) Return the device to your DAP Audio dealer.

### Sound Warping

If the sound coming out of your speaker is loud enough, but seems to be warped or distorted, your treble or bass levels may need to be adjusted.

If there are not many pieces of furniture in the room and the floor has no carpet or rug, then you will most likely have to set your treble to minus. With very little in the room to absorb the sound, too much treble can make the sound bounce off of fixtures in the room, making it tinny sounding.

With the bass, if the speaker is too close to a wall and is not aimed properly, then you will need to set the bass to minus, to stop the low tones from bouncing off of the walls or large pieces of furniture.

## Product Specifications

Model:	Pure-18S Passive 18" Subwoofer
System:	Bass-reflex Subwoofer
Power RMS:	800 W
Power peak:	1600 W
Speaker low:	18", 4" Voice coil
Frequency response (-3 dB):	35–160 Hz
Frequency response (-10 dB):	32–200 Hz
Speaker sensitivity:	104 dB / W / m
Max. SPL @ 1 m:	133 dB
Speaker impedance:	8 Ω
Crossover frequency:	125 Hz, 24 dB/Oct BW
Recommended HPF:	32 Hz, BW-24
Audio connector:	Speakon NL4 IN/OUT/MID-HIGH OUT
Housing:	18-mm Birch Plywood
Color:	Black, scratch resistant
Mounting:	35-mm/M20 pole mount
Dimensions:	600 x 520 x 655 mm (LxWxH)
Weight:	36,66 kg

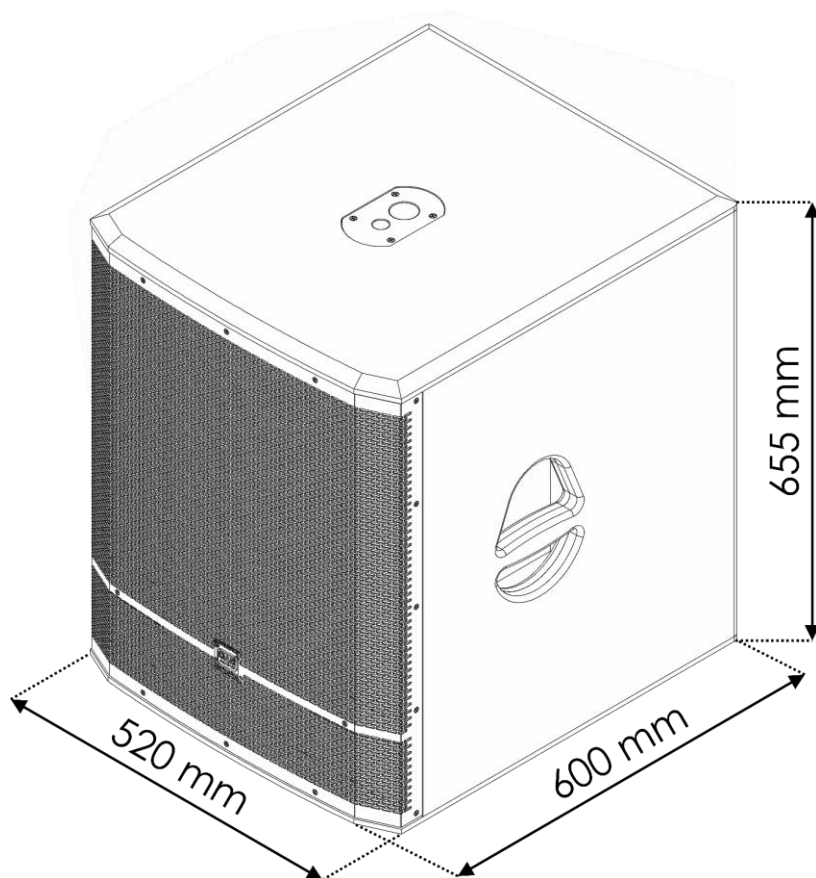

Design and product specifications are subject to change without prior notice.



Website: [www.Dap-audio.info](http://www.Dap-audio.info)  
Email: [service@highlite.com](mailto:service@highlite.com)









©2020 DAP Audio