

Battery Powered Wireless DMX Luminaire

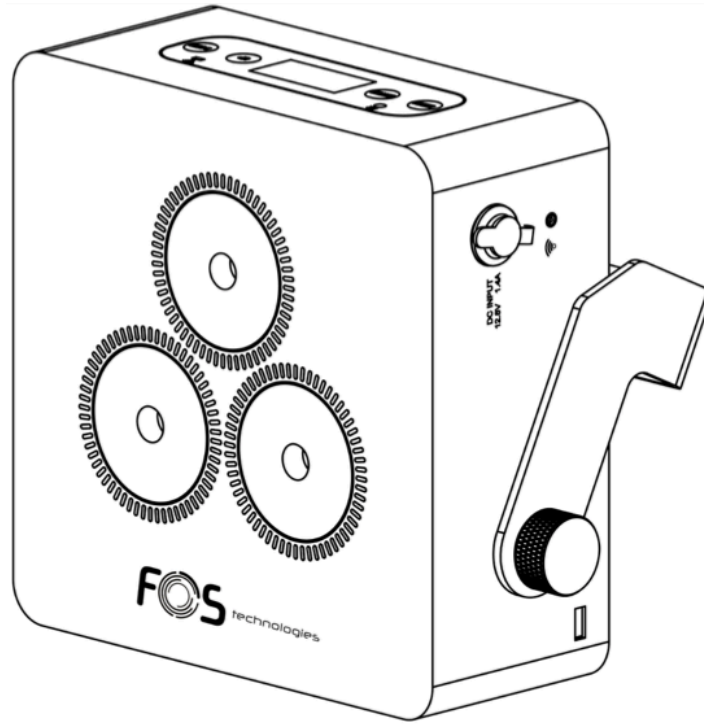

USER'S MANUAL



FOS Technologies Ltd.

Before you operate this fixture read the manual carefully. Always make sure to include the manual if you pass/rent/sell the fixture to another user.

TABLE OF CONTENT

- 1. Warning**2
 - 1.1 Safety Instructions2
 - 1.2 Rigging3
- 2. Product Introduction**3
 - 2.1 Items Included in the Package3
 - 2.2 Product Overview.....3
 - 2.3 Fixture Temperature5
 - 2.4 Storing the Fixture5
 - 2.5 Mounting6
 - 2.6 Specifications..... 7
- 3. Battery Charging**.....8
- 4. Product Setup**.....8
 - 4.1 OLED Display Setup8
 - 4.2 Menu Navigation9
 - 4.3 DMX Addressing9
 - 4.4 Wireless DMX Setup10
- 5. Operation**11
 - 5.1 DMX Control Mode.....11
 - 5.2 Auto Run Mode12
 - 5.3 Sound Mode.....12
 - 5.4 Customized Colors.....13
 - 5.5 IR Remote Control13
- 6. Maintenance**14
 - 6.1 General Maintenance14
 - 6.2 Fuse Replacement15
- 7. Warranty**16

1. WARNING

1.1 Safety Instructions

This product guide contains important information about the safe installation and use of this product. Please read and follow these instructions carefully and keep this manual in a safe place for future reference.

When unpacking and before disposing of the carton, check there is no transportation damage before using the product. Should there be any damage caused by transportation, consult your dealer and do not use the apparatus.

The product is for indoor use only. Use only in dry locations. Keep this device away from rain and moisture, excessive heat, humidity and dust. Do not allow contact with water or any other liquids. The product is not designed or intended to be mounted directly on to inflammable surfaces. 

The product is only intended for installation, operation and maintenance by qualified personnel.

The product must be installed in a location with adequate ventilation, at least 50cm from adjacent wall surfaces. Be sure that no ventilation slots are blocked.

Do not directly look into the led. It can cause harm to your eyes. Do not look at the LEDs with a magnifying glass or any other optical instrument that may concentrate the light output.

Do not attempt to dismantle and/or modify the product in any way.

Electrical connection must only be carried out by qualified personnel.

Before charging the fixture, ensure that the voltage and frequency of power supply match the power requirements of the product.

Do not directly look into the light beam. It can cause harm to your eyes. Do not look at the led with a magnifying glass or any other optical instrument that may concentrate the light output.

A rechargeable lithium ion battery is built inside this fixture. Please avoid bumping or plunging, it may cause fire or explosion. Never store the battery when fully drained. Always recharge immediately when empty.

Make sure to fully charge all fixtures before storing them. Partially charged batteries will lose capacity. Fully recharge every 6 months if not used.

When charging fixtures in flight case, always charge with the case open. It is recommended to charge at a temperature between 0°C and 35°C.

Please make sure the battery will be disposed of properly according to your local law when it runs out of its life, so that to protect the environment.

This product is not designed for permanent operation. Consistent operation breaks will ensure that the device will serve you for a long time without defects.

If this fixture is operated in any other way other than the one said in this manual, this device may suffer damages and thus the warranty becomes void.

Always switch off the fixture when it is not in use or before cleaning it or before attempting any maintenance work.

IMPORTANT:

The manufacturer will not accept liability for any resulting damages caused by the non-observance of this manual or any unauthorized modification to the fixture.

1.2 Rigging

Concerning rigging, trussing for this fixture, please follow the European and national guidelines.

Only the qualified technicians are allowed for the device installation,

The fixture must never be mounted for a possible swinging position, and a safety cord attached must always be used.

2. PRODUCT INTRODUCTION

2.1 Items Included in the Package

After receiving the fixture, please carefully unpack the product and make sure the following parts are all included inside the package and are all in good condition.

- The fixture x 4 pcs
- Charger box x 1 pcs
- Charging bag x 1 pcs
- Infrared remote controller x 1 pcs
- Power cable x 1 pcs
- This manual x 1 pcs

In case the package is damaged from shipping, inform the carrier right away while keeping the damaged box or flight case for inspection. Failure to report damage to the carrier immediately may cause invalidity to your claim. The dealer or manufacture will not take any responsibilities for the damage.

In case there are parts missing from the package with a good condition, please contact your dealer or the manufacturer immediately by email or in other written form.

2.2 Product Overview

The fixture is a battery powered led luminaire with wireless DMX receiver. It features 3 super bright RGBWA+UV hex color led, and can create more vivid color changing effects, and wide range of color temperatures.

The fixture has a rechargeable lithium-ion battery that can support 4.0 hours working at led full-color mode.

The luminaire can continue working 7 hours to run its built-in programs and around 10 hours to run single color.

Its battery is fully protected against overcharging to maximize battery life span.

The fixture uses a very stable wireless DMX receiver (W-DMX Sweden compatible). The fixture can also be controlled with infrared remote controller. The IR controller can help users to achieve all working functions.

This highly compact luminaire has very small dimensions that can be used not only as an upright but also as truss warmer. Its tilt can manually move 25 degrees when needed. It is absolutely an ideal tool for mobile DJ/Bands, wedding, exhibitions, ball room and hotel banquet halls etc.

2.2.1 Fixture Elements and Connectors

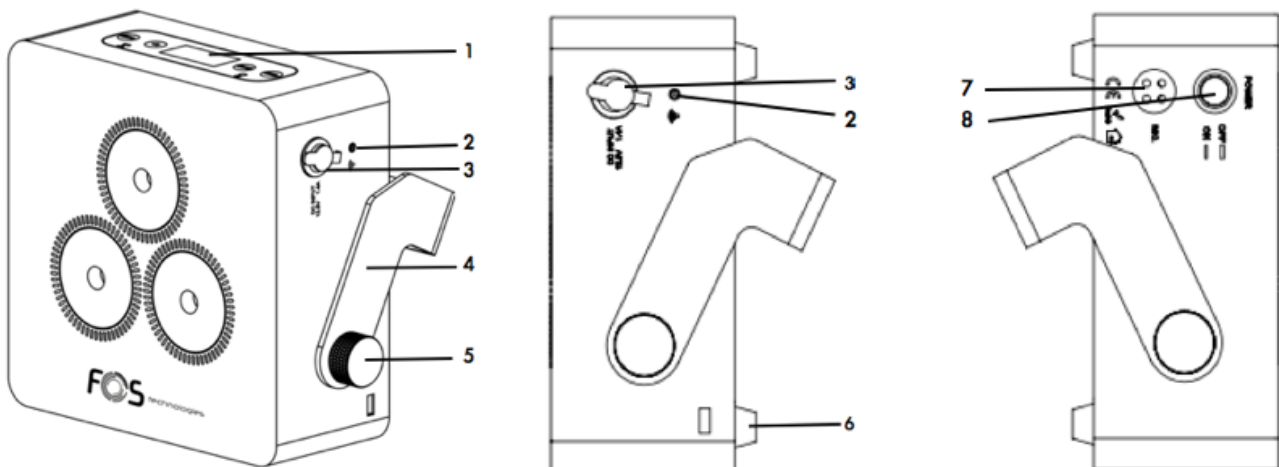

1. OLED control panel

4. Bracket

7. Microphone

2. Wireless DMX antenna

5. Turning Knob

8. Power switch

3. DC charge input

6. Rubber foot

2.2.2 Fixture Control Panel

There are 4 touch buttons on the OLED control panel: **<MENU>**, **<ENTER>**, **<UP>** and **<DOWN>**.

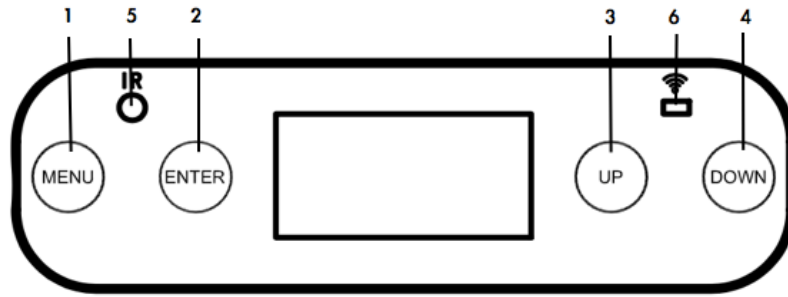

1. Menu To select the programming functions
2. Enter Enter the current menu or confirm the current function value
3. Up Scroll "UP" through the menu list to increase the value of the current function
4. Down Scroll "DOWN" through the menu list to decrease value of the current function
5. IR Infrared control sensor
6.  Wireless DMX indicator

2.2.3 Fixture Dimensions

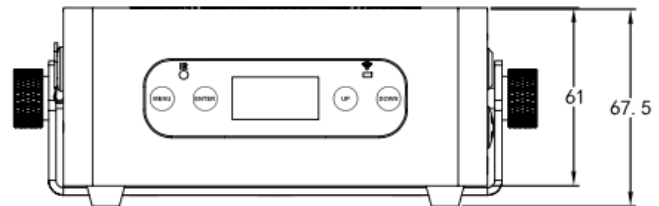
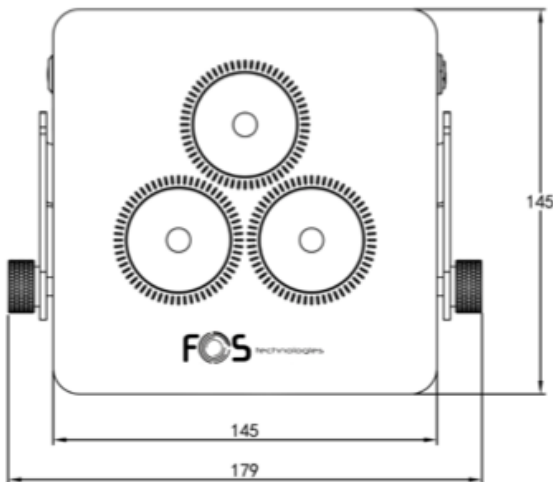

2.3 Fixture Temperature

The fixture has temperature protection function. You can easily check fixture temperature via the OLED display information menu.

When fixture temperature is higher than 65 degrees, light output will decrease to 80%. When fixture temperature is higher than 65 degrees, light output will decrease to 60%. When fixture temperature is higher than 75 degrees, leds will go off automatically until temperature comes down to 55 degrees.

2.4 Storing the Fixture

Make sure to fully charge all fixtures before storing. Partially charged batteries will lose capacity. Fully recharge every 6 months if not used.

Always remove battery fuse if fixture will be stored for long time (more than 1 month).

2.5 Mounting

The fixture can be mounted in several orientations.

2.5.1 The fixture has a highly compact housing, and can be fit inside 300x300mm truss as truss warmer.

2.5.2 The fixture has 4 rubber feet, and can sit on even and solid floor and work as an uplighter.

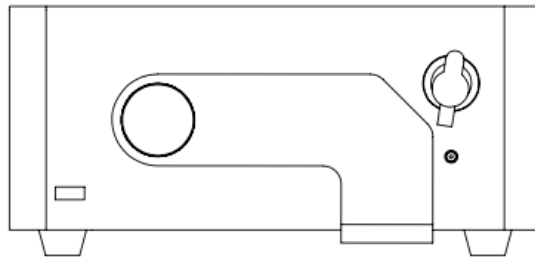

Make sure that the fixture is always placed on even and strong enough surface, and keep it 0.5m away from projection objects.

2.5.3 The fixture has multifunctional bracket. The fixture can be put on floor with various angles. It can also be installed on crossbar and truss.

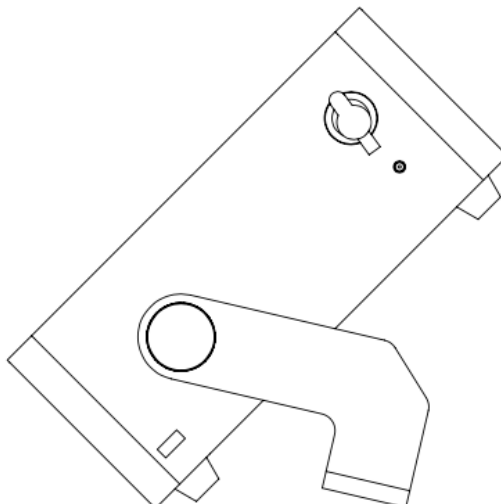

When install the fixture to crossbar and truss, always use an extra safety cord (not supplied with the fixture). Users also need to make sure the crossbar is stable or not moving, and can support a weight of 16 kg (fixture net weight 1.6kg).

For the rest of safety installation, please always respect your local regulations.

2.6 Specifications

Electrical

Power input	100-240VAC 50/60Hz
Power consumption	35W
Power input/output connector	DC input 12.8V 1.4A

Battery

Battery type	Rechargeable lithium-ion battery
Charge time	About 5.0 hours
Battery life	5 hours at full color from one full charge 5.5 - 6.0 hours full color at economy mode from one charge 8 hours at running preset programs 12 hours at running single color

Light sources

Led	3x10W, RGBWA+UV 6-in-1
Beam angle	25°
Field angle	45°
Led average life span	50,000 hours

Control

Control mode	DMX512, Master/Slave, Stand Alone; Wireless DMX, IR Remote Control
DMX channel	6/8/12 channel selectable
Control panel	OLED display with touch buttons

Physical & Construction

Housing	Rigid metal
Housing color	Black
Fixture dimensions	179 x 145 x 67.5mm
Net weight	1.6 kg
Working temperature	-10°C - 45°C
Charging temperature	0°C - 45°C
IP rating	IP20
Cooling	Natural cooling, silent operation

3. BATTERY CHARGING

The fixture has a rechargeable lithium battery and auto-ranging charger built in. Always store fixtures with full battery. Depleted batteries must be recharged immediately; otherwise fixture performance will suffer.

Battery runtime will decreased time by time. Battery runtime may be slightly shorter than predicted due to different working enviroments.

The fixture has a DC charging input. A normall charging time is about 4-5 hours.

Battery capacity can be easily seen on the OLED display.

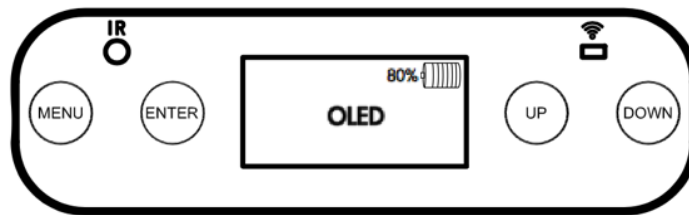

It is recommended to charge the fixture at an ambient temperature between 0°C and 35°C.

If fixture is charged but not in operation, please always keep the power switch "Off".

Note: The battery must be replaced with an original one from the manufacturer only.

4. PRODUCT SETUP

This fixture has a built-in rechargeable lithium battery. After it is fully charged, switch on the fixture, it will start to run and can be controlled with wireless DMX desk or IR controller.

After operation, please switch off the fixture with its power switch.

4.1 OLED Display Protection

OLED display can be set to turn off in 10-60 second or always "On".

Follow below steps:

- Continue pressing "Menu" till "Screensave" appears.
- Press "Enter" you will see 105, you can scroll up/down to set up how many seconds the OLED display turns off, or always "On"
- Press "Enter" to save your setting.

4.2 Menu Navigation

Main Level	2 nd Level	3 rd Level	Up/Down	Remarks
Address			001-512	DMX address 001-512
Channel			4CH/6CH/11CH	DMX channel mode
Dimmer	Dimmer OFF		normal - curve1 - curve 2 - OFF - speed 1 - speed 10	
Frequency			600Hz -1200Hz - 2000Hz - 4000Hz - 25KHz	LED frequency rate: led strobe frequency per second. The higher the frequency is, the worse dimming is, and vice verse.
Custom color	R:255 G:255 B:255 A:255		0-255	Customer saved colors
Program	Program Color	Program Strobe 0	Color1 - Color15 Strobe0 - Strobe10	Static colors + strobe
	Program Auto	Program Speed 1	Auto1 - Auto5 Speed1 - Speed10	Auto run + speed
	Program Sound	Program Sound 1	Sound 1 - Sound 9	Sound sensitivity from high to low
Mast/Slave	Master/Slave	Master - Pairing Slave - Clear	Master/Slave	
Information	Ver: V1.00 Ontime: 00H00M00S Runtime: 0000H00M Temp: 00F			Software version Fixture total run time This run time Temperature
Screensaving			10S - 60S / OLED On	OLED Black time:10S-60S; OLED ON:OLED always on
Wireless Reset	No/Yes			wireless DMX reset
IR			On/Off	Infrared remote control

4.3 DMX Addressing

Each fixture must be given a DMX address so that the correct fixture responds to the correct control signals. This DMX address is the channel number from which the fixture starts to "listen" to the digital control information being sent out from the controller.

This fixture has 3 DMX channel modes, 6, 8 and 12 DMX channels. To set up fixture DMX address, first select DMX channel mode. The highest DMX address for this fixture is 512. To set up fixture DMX starting address, follow the steps below:

- Switch on the fixture, press Menu till "Channel" appears;
- Press "Up" or "Down" button to select 6CH or 8CH or 12CH;
- Press "Enter" to confirm your select.
- Press "Menu" repeatedly to come back to "Address 001";
- Set up DMX address by scrolling "Up"/" Down" button.
- Press "Enter" to save your setting.
-

4.4 Wireless DMX Setup

This fixture can be controlled via wireless DMX system. Users need to pair the fixture to wireless DMX transmitter first.

There is one wireless DMX indicator near the OLED display. This indicator shows status of wireless DMX connection.

Indicator Status	Description
Blue light on	Fixture receiving wireless DMX signal from transmitter.
Blue light slow flashing	Fixture already connected to transmitter, but no signal coming from transmitter.
Blue light fast flashing	Fixture no connection to transmitter; fixture keeps. Wireless DMX memory from last pair.
Bluelight off	Fixture no connection to transmitter, and no any wireless DMX memory.

4.4.1 Pairing

- After fixture is switched on, and if there is no new transmitter, fixture will connect to the old transmitter automatically, no need to re-pair it.
- To clear wireless DMX memory, go to "menu" scroll up till you see "Wireless Reset", press Up/Down to select "Yes" and press "Enter" to reset wireless DMX. Then the blue light will turn off in about 5 seconds.
- To pair fixture and transmitter, after fixture wireless DMX is reset (make sure wireless DMX indicator is Off), then press the pair button on the transmitter, fixture indicator will start to fast flashing and then stay on, pair succeeds.

In optimal conditions, the master unit can operate up to 350m (visible distance) away from the slave units. Please keep obstacles free between fixtures.

Once units have been linked to a specific transmitter, it will remain linked to that unit units it is linked to another one by clearing the intial wireless DMX signal.

To clear wireless DMX signal, set up your fixture as Slave first. Press "Enter", slave unit will start to erase all wireless DMX signal. Wireless DMX indicator will turn off in 5 seconds.

4.4.2 Wireless DMX Reset

To reset the fixture wirelss DMX signal, continue pressing "Menu" till "Wireless" appears. Press Up/Down to select "Yes" or "No", then press Enter to save your setup.

5. OPERATION

5.1 DMX Control Mode

This function will allow users to control individual fixture with a standard DMX 512 console. Below is fixture DMX Channel Chart.

Channel Mode	Channel	Function	DMX Value	Description
6 Ch	1	Red	0-255	0-100%
	2	Green	0-255	0-100%
	3	Blue	0-255	0-100%
	4	White	0-255	0-100%
	5	Amber	0-255	0-100%
	6	UV	0-255	0-100%
8 CH	1	Red	0-255	0-100%
	2	Green	0-255	0-100%
	3	Blue	0-255	0-100%
	4	White	0-255	0-100%
	5	Amber	0-255	0-100%
	6	UV	0-255	0-100%
	7	Dimming	0-255	0-100%
	8	Strobe	0-15	No function
16-255	Strobe from slow to fast			
12 CH	1	Red	0-255	0-100%
	2	Green	0-255	0-100%
	3	Blue	0-255	0-100%
	4	White	0-255	0-100%
	5	Amber	0-255	0-100%
	6	UV	0-255	0-100%
	7	Dimming	0-255	0-100%
	8	Strobe	0-10	No function
	11-255		Strobe from slow to fast	
	9	Colors macro & white balance	0-10	No function
			11-30	R:100% G:0-100% B: 0
			31-50	R: 100%-0 G100% B: 0
			51-70	R:0 G:100% B: 0-100%
			71-90	R: 0 G: 100%-0 B: 100%
			91-110	R: 0-100% G:0 B: 100%
			111-130	R: 100% G: 0 B: 100%-0
			131-150	R: 100% G: 0-100% B: 0-100%
			151-170	R: 100%-0 G:100%-0 B: 100%
			171-200	R: 100% G: 100% B:100%
201-205			White 1	

12 CH	9	Colors macro & white balance	206-210	White 2
			211-215	White 3
			216-220	White 4
			221-225	White 5
			226-230	White 6
			231-235	White 7
			236-240	White 8
			241-245	White 9
			246-250	White 10
			251-255	White 11
	10	Auto run	0-10	No function
			11-40	RGB color mixing
			41-70	CMY color mixing
			71-100	RGBA color mixing
			101-130	RGBACMY color mixing
			131-160	RGB color changing
			161-190	CMY color changing
			191-220	RGBA color changing
	221-255	RGBACMY color changing		
	11	Auto speed	0-255	From slow to fast
12	Sound	0-10	No function	
		11-255	Sound mode	

5.2 Auto Run Mode

The fixture has preset color mixing and fading programs that can be activated from the OLED control panel for auto running. To access this, follow below steps:

- Press button "Menu" until "Program" appears.
- Press "Up" or "Down" to scroll up/down to select "Auto" and "Color";
- Press "Enter" to confirm your run mode;
- Scroll "Up" or "Down" to select Auto programs (from 1 -5) or "Color" (from 1-30).

5.3 Sound Mode

The fixture can operate at sound mode to activate built-in programs with music.

Continue pressing "Menu" till "Program" appears. Press "Up" or "Down" to scroll up/down to select "Sound". Press "Enter" to save the setting.

Press "Up" or "Down" to adjust sound sensitivity from high to low (from 1 to 9).

5.4 Customized Colors

Users are allowed to program their own color effects and save to your fixture. Follow the steps below:

- Press button "Menu" until "Color Custom 1" appears.
- Press "Enter", you will see R (Red) is flashing, this means you now can program red color, press again "Enter" and scroll "Up" or "Down" to adjust red intensity, press "Enter" again to save your setup.

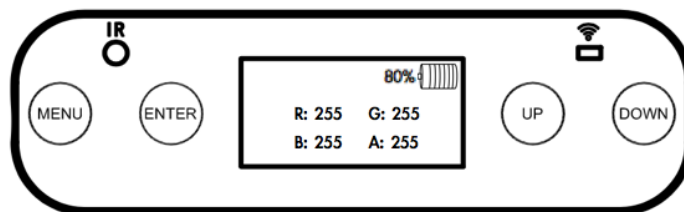

- To select other colors "Up" or "Down" and press "Enter" to confirm the color you selected.
- Then scroll "Up" or "Down" to adjust the color intensity, and press "Enter" to save it

5.5 IR Remote Control

This operation mode allows users to control the fixture with an infrared remote controller. The remote controller can help you to achieve almost all functions.

To activate IR remote control, press "Menu" until "IR" appears, press "Up" or "Down" button and select "On". Press "Enter" to save the setting.









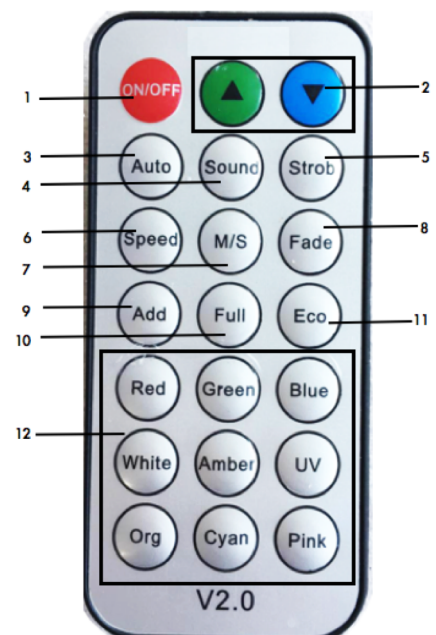







To control the fixture with this IR remote controller, make sure to point the controller directly to the IR receiving sensors on the product. Make sure there are no objects between the controller and the fixture.

1 - Set the fixture into blackout (LED on/off).

2 - Adjust auto, strobe & fade speed, sound sensitivity, DMX address, DMX channel, brightness etc.

3 - Run auto mode, use "Speed" button followed by the   buttons to adjust auto speeds.



- 4 – Run sound program, use   buttons to adjust sound sensitivity.
- 5 – Run strobe program, use   buttons to adjust strobe speed.
- 6 – Set auto/fade speed, Press this button followed by   buttons to adjust program speed.
- 7 – Set the fixture into master or slave mode.
- 8 – Run fade mode. Use “Speed” button followed by   buttons to adjust fade speed.
- 9 - Set DMX address. Press this button followed by   to set up DMX address. Press this button again followed by   to select DMX channel.
- 10 – Set the fixture in full brightness. Press this button followed by   buttons to adjust brightness.
- 11 – Set the fixture in ECO mode. Press this button followed by   buttons to turn ECO mode on/off.
- 12 – Set static color. This fixture has RGBA leds, so “White” and “UV” buttons are invalid.

6. MAINTENANCE

6.1 General Maintenance

The operator has to make sure that the safety-related and machine-technical installations are to be inspected by an expert once a year in the course of an acceptance test.

The operator has to make sure that safety-related and machine-technical installations are to be inspected by a skilled person once a year.

The following points have to be considered during the inspection:

- Make sure connections are clean and totally dry before linking equipments or supplying electric power.
- All screws used for installing the fixture or parts of the fixture have to be tightly connected and must not be corroded.

The fixture has optical lenses; users should clean the lenses periodically to optimize light output. The cleaning frequency depends on the environment in which the curtain system is installed. Damp, smoky or particularly dirty surrounding can cause greater accumulation of dirt on the lenses. Even in a clean type of surroundings, it is suggested to clean the lens and housing at least once a month. It is suggested to use a soft cloth using normal glass cleaning fluid.

The following points have to be considered during the maintenance:

- Switch off the fixture before cleaning.
- Clean the lens with a mild solution of glass cleaner or isopropyl alcohol, and a soft, lint free cotton cloth or a lens cleaning tissue.
- Gently polish the external glass surfaces until they are free of haze and lint.

6.2 Fuse Replacement

The fixture has an internal replaceable fuse built in the base.

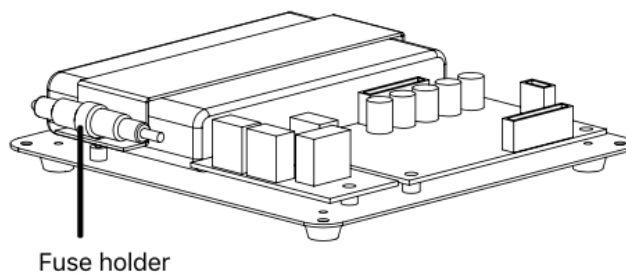

In case fuse is blown, you need to replace it. Unplug the fixture from power, remove the 4 screw from the housing to find the fuse holder. Open the fuse holder by turning it anticlockwise; remove the blown fuse from the holder and replace it with the exact same type and rating one. Close the fuse holder by turning it clockwise to tighten it. Screw back the base to the housing.

Always replace a blown fuse with another of the same type and rating.

7. WARRANTY

The manufatuere, hereby warrants, to the original purchaser, our products to be free of manufacturing defects in material and workmanship for a period of one year (365 days) from the date of purchase. It is the owner's responsibility to establish the data and place of purchase by acceptable evidence, at the time service is sought. This warranty is void if the serial number has been altered or removed; if the product is modified in any manner that the manufatuere concludes, after inspecting, affects the reliability of the product; if the product has been repaired or serviced by anyone other than the manufatuere unless prior written authorization was issued to purchaser by the manufatuere. If the product is damaged because not properly maintained as set forth in the instruction manual. No warranty, whether expressed or implied, is given or made with respect to any accessory supplier with products described above. The consumer's and or Dealer's sole remedy shall be such repair or replacement as is expressly provided.; and under no circumstances shall the manufatuere be liable for any loss or damage, direct or consequential, arising out of the use of, or inability to use, this product. This warranty is the only written warranty applicable to the manufatuere. Products and supersedes all prior warranties and written descriptions of warranty terms and conditions heretofore published. The manufatuere reserves the right to make changes in design and/or improvements upon its products without any obligation to include these changes in any products theretofore manufactured.

No content in this page

Battery Powered Wireless DMX Luminaire

USER'S MANUAL



FOS Technologies Ltd.

Dealer info:

Copyright reserved

Manual version: Ver 1.0

Date: 20180512